



CATÁLOGO

CATAPTV20

EDICIÓN

2020

TRANSMISIÓN DE POTENCIA BANDA EN V





DRIVEN BY POSSIBILITY™





DRIVEN BY POSSIBILITY™

HI POWER®

LAS BANDAS HI POWER® TIENEN CARACTERÍSTICAS QUE LAS HACEN ÚNICAS EN EL MERCADO; GATES SE HA PREOCUPADO POR DISEÑAR EL MEJOR PRODUCTO.



Catálogo Transmisión de Potencia Banda en V

Introducción.....	3	Bandas Super HC®	
Bandas Hi Power® II.....	4	Dentada Moldeada Powerband®	62
Bandas Hi Power® II Powerband®.....	12	Bandas Predator®	65
Bandas Tri Power®.....	17	Bandas Predator® Powerband®	70
Bandas Metric Power®V.....	21	Poleas Super HC® QD®	74
Bandas Hi Power® II Doble V.....	27	Poleas Hi Power® QD®	81
Bandas Micro V®.....	30	Bujes QD® Tamaños Ingleses.....	96
Bandas Velocidad Variable.....	34	Bujes QD® Tamaños Milimétricos.....	99
Bandas Truflex®V.....	41	Bujes QD® Retrabajables.....	100
Bandas Polyflex®.....	46	Bujes TL® Tamaños Ingleses.....	101
Bandas Polyflex® JB®.....	49		
Bandas Super HC® Dentada Moldeada.....	55		
Bandas Super HC® Powerband®.....	58		

BANDAS EN V GATES®

EL PODER DETRÁS DE LA TRANSMISIÓN DE POTENCIA

Gates fabrica la línea más grande de bandas trapezoidales estándar en la industria. Gates cuenta con un extenso y accesible inventario de productos con un rendimiento inigualable, características y alcance ilimitado.

EL ALTO COSTO DEL BAJO RENDIMIENTO EN BANDAS EN V

Las bandas trapezoidales son esenciales para la transmisión de potencia en aplicaciones industriales. El deslizamiento, el estiramiento y el desgaste de la banda provocan grandes problemas para la mayoría de las instalaciones, con un tiempo de inactividad excesivo requiriendo constantemente retensado, mantenimiento y reemplazo de bandas de bajo rendimiento. Ahorrar dinero por adelantado con bandas trapezoidales menos costosas puede parecer una buena opción; sin embargo, los costos ocultos asociados con la elección de bandas de bajo rendimiento, son más altos.

MAXIMIZAR LA EFICIENCIA Y AHORRAR EN COSTOS

La innovación en ciencia de materiales de Gates nos permite ofrecer la gama más amplia de transmisiones por banda para las condiciones más exigentes. Nuestra línea integral de bandas está diseñada para mejorar la fiabilidad, y eficiencia, mientras se maximiza el rendimiento y garantiza una larga vida.

APLICACIONES SIN FIN

- Disminuir los costos operacionales.
- Maximizar el tiempo de producción.
- Reducir los costos de mantenimiento.

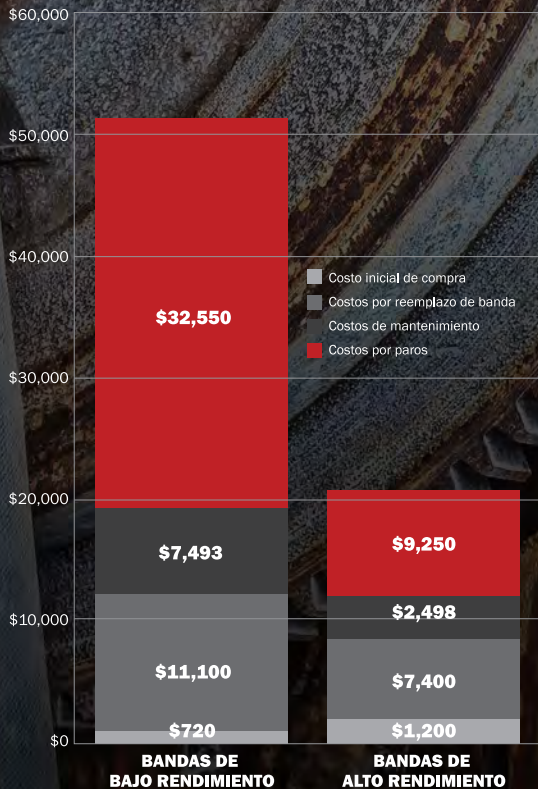

*Ahorros considerados en un año bajo condiciones controladas

BANDAS HI POWER® II

Esta banda tiene aplicaciones multi-propósito, resisten petróleo, calor, ozono, luz del sol y condiciones atmosféricas adversas y envejecimiento.

MERCADOS/APLICACIONES

La mejor opción para todas las aplicaciones industriales.

CARACTERÍSTICAS/VENTAJAS

- Las curvas de Gates® proporcionan máximo soporte y contacto con la ranura de la polea, proporcionando una distribución uniforme de la carga y larga vida útil.
- Las cuerdas están unidas fuertemente al cuerpo de la banda resultando en una absorción de los esfuerzos, aun cuando circule por poleas de diámetro pequeño, sin deterioro de la cuerda.
- La Cubierta Flex Weave trenzada es una construcción patentada, de larga vida útil y proporciona protección al cuerpo de la banda del petróleo, polvo y calor.
- Satisface los estándares RMA de resistencia al petróleo y al calor.
- Satisface los requerimientos RMA de conductividad estática.

Poleas recomendadas: Poleas Multi-Duty

Notas: Las bandas Gates Hi Power® están disponibles en secciones A, B, C, D y E.

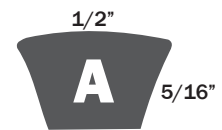
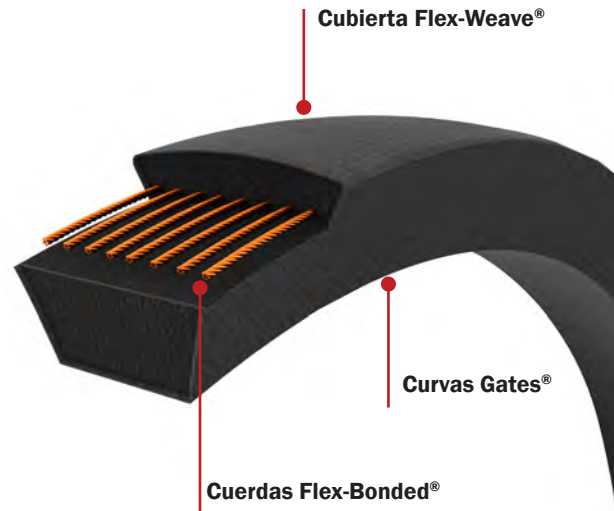

BANDA HI-POWER®

SECCIÓN A

DESCRIPCIÓN	CÓDIGO	LONG. (PULG.)	PESO (LBS.)	DESCRIPCIÓN	CÓDIGO	LONG. (PULG.)	PESO (LBS.)
A16	91120016	18	0.138	A24	91122024	26	0.17
A17	91120017	19	0.142	A25	91122025	27	0.18
A18	91120018	20	0.146	A26	91122026	28	0.19
A19	91120019	21	0.15	A27	91122027	29	0.20
A20	91120020	22	0.154	A28	91122028	30	0.21
A21	91120021	23	0.158	A29	91122029	31	0.22
A22	91120022	24	0.162	A30	91122030	32	0.23
A23	91120023	25	0.17	A31	91122031	33	0.24

BANDA HI-POWER®**SECCIÓN A**

DESCRIPCIÓN	CÓDIGO	LONG. (PULG.)	PESO (LBS.)	DESCRIPCIÓN	CÓDIGO	LONG. (PULG.)	PESO (LBS.)
A32	91122032	34	0.25	A75	91122075	77	0.52
A33	91122033	35	0.26	A76	91122076	78	0.53
A34	91122034	36	0.27	A77	91122077	79	0.53
A35	91122035	37	0.28	A78	91122078	80	0.53
A36	91122036	38	0.29	A79	91122079	81	0.54
A37	91122037	39	0.30	A80	91122080	82	0.54
A38	91122038	40	0.31	A81	91122081	83	0.55
A39	91122039	41	0.32	A82	91122082	84	0.57
A40	91122040	42	0.33	A83	91122083	85	0.57
A41	91122041	43	0.34	A84	91122084	86	0.58
A42	91122042	44	0.35	A85	"91122085	87	0.59
A43	91122043	45	0.36	A85	91122085	87	0.6
A44	91122044	46	0.37	A86	91122086	88	0.61
A45	91122045	47	0.38	A87	91122087	89	0.61
A46	91122046	48	0.39	A88	91122088	90	0.62
A47	91122047	49	0.40	A89	91122089	91	0.62
A48	91122048	50	0.41	A90	91122090	92	0.63
A49	91122049	51	0.42	A91	91122091	93	0.63
A50	91122050	52	0.42	A92	91122092	94	0.64
A51	91122051	53	0.42	A93	91122093	95	0.64
A52	91122052	54	0.43	A94	91122094	96	0.65
A53	91122053	55	0.43	A95	91122095	97	0.65
A54	91122054	56	0.44	A96	91122096	98	0.66
A55	91122055	57	0.44	A97	91122097	99	0.66
A56	91122056	58	0.45	A98	91122098	100	0.67
A57	91122057	59	0.45	A99	91122099	101	0.67
A58	91122058	60	0.45	A100	91122100	102	0.7
A59	91122059	61	0.46	A102	91122102	104	0.71
A60	91122060	62	0.46	A103	91122103	105	0.72
A61	91122061	63	0.47	A104	91122104	106	0.73
A62	91122062	64	0.47	A105	91122105	107	0.74
A63	91122063	65	0.47	A106	91122106	108	0.75
A64	91122064	66	0.48	A107	91122107	109	0.75
A65	91122065	67	0.48	A108	91122108	110	0.76
A66	91122066	68	0.49	A110	91122110	112	0.77
A67	91122067	69	0.49	A112	91122112	114	0.78
A68	91122068	70	0.49	A118	91122118	120	0.83
A69	91122069	71	0.50	A120	91122120	122	0.84
A70	91122070	72	0.50	A124	91122124	126	0.85
A71	91122071	73	0.51	A125	91122125	127	0.87
A72	91122072	74	0.51	A126	91122126	128	0.87
A73	91122073	75	0.51	A127	91122127	129	0.87
A74	91122074	76	0.52	A128	91122128	130	0.87

BANDA HI-POWER®**SECCIÓN A**

DESCRIPCIÓN	CÓDIGO	LONG. (PULG.)	PESO (LBS.)
A129	91122129	131	0.87
A130	91122130	132	0.87
A132	91122132	134	0.94
A136	91122136	138	0.94
A140	91122140	142	0.96
A142	91122142	144	0.98
A144	91122144	146	1.02
A146	91122146	148	1.02
A148	91122148	150	1.03
A149	91122149	151	1.03
A152	91122152	154	1.03

DESCRIPCIÓN	CÓDIGO	LONG. (PULG.)	PESO (LBS.)
A158	91122158	160	1.05
A162	91122162	164	1.06
A165	91122165	167	1.09
A166	91122166	168	1.2
A173	91122173	175	1.2
A180	91122180	182	1.3
A194	91122194	196	1.3
A196	91122196	198	1.3
A198	91122198	200	1.3
A210	91122210	212	1.4

21/32"

**BANDA HI-POWER®****SECCIÓN B**

DESCRIPCIÓN	CÓDIGO	LONG. (PULG.)	PESO (LBS.)
B24	91133024	27	0.32
B25	91133025	28	0.33
B26	91133026	29	0.33
B27	91133027	30	0.34
B28	91133028	31	0.35
B29	91133029	32	0.36
B30	91133030	33	0.37
B31	91133031	34	0.38
B32	91133032	35	0.39
B33	91133033	36	0.40
B34	91133034	37	0.41
B35	91133035	38	0.42
B36	91133036	39	0.43
B37	91133037	40	0.44
B38	91133038	41	0.45
B39	91133039	42	0.47
B40	91133040	43	0.48
B41	91133041	44	0.50
B42	91133042	45	0.51
B43	91133043	46	0.53
B44	91133044	47	0.54
B45	91133045	48	0.56
B46	91133046	49	0.57

DESCRIPCIÓN	CÓDIGO	LONG. (PULG.)	PESO (LBS.)
B47	91133047	50	0.59
B48	91133048	51	0.60
B49	91133049	52	0.62
B50	91133050	53	0.63
B51	91133051	54	0.65
B52	91133052	55	0.66
B53	91133053	56	0.67
B54	91133054	57	0.69
B55	91133055	58	0.70
B56	91133056	59	0.71
B57	91133057	60	0.71
B58	91133058	61	0.7204
B59	91133059	62	0.73
B60	91133060	63	0.74
B61	91133061	64	0.74
B62	91133062	65	0.75
B63	91133063	66	0.7584
B64	91133064	67	0.77
B65	91133065	68	0.77
B66	91133066	69	0.78
B67	91133067	70	0.79
B68	91133068	71	0.7964

BANDA HI-POWER®**SECCIÓN B**

DESCRIPCIÓN	CÓDIGO	LONG. (PULG.)	PESO (LBS.)	DESCRIPCIÓN	CÓDIGO	LONG. (PULG.)	PESO (LBS.)
B69	91133069	72	0.80	B118	91133118	121	1.43
B70	91133070	73	0.81	B119	91133119	122	1.44
B71	91133071	74	0.82	B120	91133120	123	1.46
B72	91133072	75	0.83	B121	91133121	124	1.47
B73	91133073	76	0.8344	B122	91133122	125	1.49
B74	91133074	77	0.84	B123	91133123	126	1.5
B75	91133075	78	0.85	B124	91133124	127	1.52
B76	91133076	79	0.86	B125	91133125	128	1.53
B77	91133077	80	0.86	B126	91133126	129	1.55
B78	91133078	81	0.87	B127	91133127	130	1.56
B79	91133079	82	0.88	B128	91133128	131	1.58
B80	91133080	83	0.89	B129	91133129	132	1.59
B81	91133081	84	0.90	B130	91133130	133	1.61
B82	91133082	85	0.90	B131	91133131	134	1.62
B83	91133083	86	0.94	B132	91133132	135	1.64
B84	91133084	87	1	B133	91133133	136	1.65
B85	91133085	88	1	B134	91133134	137	1.67
B86	91133086	89	1	B135	91133135	138	1.68
B87	91133087	90	1	B136	91133136	139	1.7
B88	91133088	91	1.01	B137	91133137	140	1.7
B89	91133089	92	1.01	B138	91133138	141	1.7
B90	91133090	93	1.01	B139	91133139	142	1.72
B91	91133091	94	1.03	B140	91133140	143	1.73
B92	91133092	95	1.04	B141	91133141	144	1.73
B93	91133093	96	1.05	B142	91133142	145	1.74
B94	91133094	97	1.07	B143	91133143	146	1.748
B95	91133095	98	1.08	B144	91133144	147	1.76
B96	91133096	99	1.1	B146	91133146	149	1.76
B97	91133097	100	1.11	B147	91133147	150	1.77
B98	91133098	101	1.13	B148	91133148	151	1.78
B99	91133099	102	1.14	B150	91133150	153	1.783
B100	91133100	103	1.16	B151	91133151	154	1.79
B101	91133101	104	1.17	B152	91133152	155	1.8
B102	91133102	105	1.19	B153	91133153	156	1.8
B103	91133103	106	1.2	B154	91133154	157	1.81
B104	91133104	107	1.22	B155	91133155	158	1.818
B105	91133105	108	1.23	B156	91133156	159	1.83
B106	91133106	109	1.25	B157	91133157	160	1.83
B107	91133107	110	1.26	B158	91133158	161	1.84
B108	91133108	111	1.28	B160	91133160	163	1.85
B109	91133109	112	1.29	B162	91133162	165	1.85
B110	91133110	113	1.31	B163	91133163	166	1.86
B111	91133111	114	1.32	B164	91133164	167	1.88
B112	91133112	115	1.34	B165	91133165	168	1.89
B113	91133113	116	1.35	B166	91133166	169	1.9
B114	91133114	117	1.37	B167	91133167	170	1.92
B115	91133115	118	1.38	B168	91133168	171	1.93
B116	91133116	119	1.4	B169	91133169	172	1.95
B117	91133117	120	1.41	B170	91133170	173	1.96

BANDA HI-POWER®

SECCIÓN B

DESCRIPCIÓN	CÓDIGO	LONG. (PULG.)	PESO (LBS.)	DESCRIPCIÓN	CÓDIGO	LONG. (PULG.)	PESO (LBS.)
B173	91133173	176	1.97	B229	91133229	232	2.61
B175	91133175	178	1.99	B230	91133230	233	2.64
B176	91133176	179	2	B236	91133236	239	2.66
B177	91133177	180	2.02	B238	91133240	241	2.68
B178	91133178	181	2.03	B240	91133238	243	2.72
B180	91133180	183	2.04	B244	91133244	247	2.76
B185	91133185	188	2.06	B245	91133245	248	2.80
B186	91133186	189	2.07	B246	91133246	249	2.84
B187	91133187	190	2.09	B250	91133250	253	2.89
B188	91133188	191	2.1	B252	91133252	255	2.93
B189	91133189	192	2.11	B255	91133255	258	2.97
B190	91133190	193	2.11	B256	91133256	259	3.01
B192	91133192	195	2.13	B257	91133257	260	3.05
B195	91133195	198	2.16	B259	91133259	262	3.09
B196	91133196	199	2.18	B260	91133260	263	3.13
B197	91133197	200	2.21	B261	91133261	264	3.17
B198	91133198	201	2.23	B264	91133264	267	3.21
B200	91133200	203	2.25	B265	91133265	268	3.25
B202	91133202	205	2.28	B270	91133270	273	3.3
B204	91133204	207	2.3	B272	91133272	275	3.34
B205	91133205	208	2.33	B275	91133275	276	3.38
B208	91133208	211	2.35	B276	91133276	279	3.42
B210	91133210	213	2.37	B280	91133280	283	3.46
B214	91133214	217	2.4	B285	91133285	288	3.5
B216	91133216	219	2.42	B300	91133300	301	3.58
B220	91133220	223	2.45	B310	91133310	313	3.7
B221	91133221	224	2.47	B315	91133315	318	3.76
B222	91133222	225	2.49	B323	91133323	326	3.76
B225	91133225	226	2.52	B330	91133330	333	4.6
B223	91133223	226	2.54	B360	91133360	363	4.83
B227	91133227	230	2.57	B364	91133364	367	5.23
B228	91133228	231	2.59	B394	91133394	397	5.63

BANDAS HI-POWER®

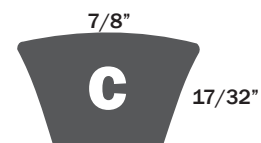

BANDA HI-POWER®

SECCIÓN C

DESCRIPCIÓN	CÓDIGO	LONG. (PULG.)	PESO (LBS.)	DESCRIPCIÓN	CÓDIGO	LONG. (PULG.)	PESO (LBS.)
C52	91144052	56	1.13	C60	91144060	64	1.31
C54	91144054	58	1.16	C61	91144061	65	1.33
C55	91144055	59	1.18	C62	91144062	66	1.36
C56	91144056	60	1.21	C63	91144063	67	1.38
C57	91144057	61	1.23	C64	91144064	68	1.41
C58	91144058	62	1.26	C65	91144065	69	1.43
C59	91144059	63	1.28	C66	91144066	70	1.46

BANDA HI-POWER®**SECCIÓN C**

DESCRIPCIÓN	CÓDIGO	LONG. (PULG.)	PESO (LBS.)	DESCRIPCIÓN	CÓDIGO	LONG. (PULG.)	PESO (LBS.)
C67	91144067	71	1.48	C111	91144111	115	2.19
C68	91144068	72	1.51	C112	91144112	116	2.20
C69	91144069	73	1.53	C113	91144113	117	2.22
C70	91144070	74	1.54	C114	91144114	118	2.23
C71	91144071	75	1.55	C115	91144115	119	2.25
C72	91144072	76	1.56	C116	91144116	120	2.26
C73	91144073	77	1.57	C118	91144118	122	2.28
C74	91144074	78	1.58	C119	91144119	123	2.38
C75	91144075	79	1.59	C120	91144120	124	2.38
C76	91144076	80	1.59	C121	91144121	125	2.40
C77	91144077	81	1.60	C122	91144122	126	2.42
C78	91144078	82	1.61	C123	91144123	127	2.45
C79	91144079	83	1.62	C124	91144124	128	2.47
C80	91144080	84	1.63	C125	91144125	129	2.49
C81	91144081	85	1.64	C126	91144126	130	2.51
C82	91144082	86	1.65	C127	91144127	131	2.53
C83	91144083	87	1.66	C128	91144128	132	2.56
C84	91144084	88	1.67	C130	91144130	134	2.58
C85	91144085	89	1.68	C131	91144131	135	2.60
C86	91144086	90	1.68	C132	91144132	136	2.62
C87	91144087	91	1.69	C133	91144133	137	2.64
C88	91144088	92	1.70	C134	91144134	138	2.67
C89	91144089	93	1.71	C136	91144136	140	2.69
C90	91144090	94	1.79	C144	91144144	148	2.85
C91	91144091	95	1.80	C145	91144145	149	2.87
C92	91144092	96	1.82	C146	91144146	150	2.89
C93	91144093	97	1.83	C147	91144147	151	2.92
C94	91144094	98	1.84	C148	91144148	152	2.94
C95	91144095	99	1.86	C150	91144150	154	2.96
C96	91144096	100	1.87	C151	91144151	155	2.98
C97	91144097	101	1.88	C152	91144152	156	3.00
C98	91144098	102	1.89	C153	91144153	157	3.03
C99	91144099	103	1.91	C154	91144154	158	3.05
C100	91144100	104	1.92	C156	91144156	160	3.07
C101	91144101	105	1.93	C157	91144157	161	3.09
C102	91144102	106	1.95	C158	91144158	162	3.11
C103	91144103	107	1.96	C160	91144160	164	3.14
C104	91144104	108	1.97	C162	91144162	166	3.16
C105	91144105	109	1.99	C164	91144164	168	3.18
C106	91144106	110	2.00	C165	91144165	169	3.20
C108	91144108	112	2.14	C166	91144166	170	3.22
C109	91144109	113	2.16	C167	91144167	171	3.25
C110	91144110	114	2.17	C168	91144168	172	3.27

BANDA HI-POWER®**SECCIÓN C**

DESCRIPCIÓN	CÓDIGO	LONG. (PULG.)	PESO (LBS.)	DESCRIPCIÓN	CÓDIGO	LONG. (PULG.)	PESO (LBS.)
C170	91144170	174	3.29	C195	91144195	199	3.62
C173	91144173	177	3.31	C197	91144197	201	3.64
C175	91144175	179	3.33	C198	91144198	202	3.66
C177	91144177	181	3.36	C199	91144199	203	3.69
C178	91144178	182	3.38	C200	91144200	204	4.27
C180	91144180	184	3.40	C202	91144202	206	4.29
C182	91144182	186	3.42	C203	91144203	207	4.31
C183	91144183	187	3.44	C204	91144204	208	4.34
C184	91144184	188	3.47	C205	91144205	209	4.36
C185	91144185	189	3.49	C207	91144207	211	4.38
C187	91144187	191	3.51	C210	91144210	214	4.40
C190	91144190	194	3.53	C220	91144220	224	4.42
C192	91144192	196	3.55	C225	91144225	227	4.45
C193	91144193	197	3.58	C228	91144228	232	4.47
C194	91144194	198	3.60	C230	91144230	234	4.49

**BANDA HI-POWER®****SECCIÓN D**

DESCRIPCIÓN	CÓDIGO	LONG. (PULG.)	PESO (LBS.)	DESCRIPCIÓN	CÓDIGO	LONG. (PULG.)	PESO (LBS.)
D90	91155090	95	4.90	D144	91155144	149	6.34
D93	91155093	98	4.98	D145	91155145	150	6.42
D95	91155095	100	5.06	D147	91155147	152	6.50
D97	91155097	102	5.14	D148	91155148	153	6.58
D100	91155100	105	5.22	D150	91155150	155	6.66
D105	91155105	110	5.30	D152	91155152	157	6.74
D108	91155108	113	5.38	D154	91155154	159	6.82
D112	91155112	117	5.46	D156	91155156	161	6.90
D115	91155115	120	5.54	D158	91155158	163	6.98
D120	91155120	125	5.62	D162	91155162	167	7.06
D124	91155124	129	5.70	D164	91155164	169	7.14
D128	91155128	133	5.78	D168	91155168	173	7.22
D130	91155130	135	5.86	D170	91155170	175	7.30
D135	91155135	140	5.94	D173	91155173	178	7.38
D136	91155136	141	6.02	D180	91155180	185	7.76
D138	91155138	143	6.10	D185	91155185	190	7.84
D139	91155139	144	6.18	D195	91155195	200	8.31
D140	91155140	145	6.26	D198	91155198	203	9.10

BANDA HI-POWER®**SECCIÓN D**

DESCRIPCIÓN	CÓDIGO	LONG. (PULG.)	PESO (LBS.)	DESCRIPCIÓN	CÓDIGO	LONG. (PULG.)	PESO (LBS.)
D204	91155204	209	9.37	D315	91155315	318	13.90
D210	91155210	215	9.64	D330	91155330	333	14.66
D215	91155215	220	9.91	D345	91155345	350	14.96
D225	91155225	228	10.18	D350	91155350	355	15.26
D230	91155230	235	10.45	D360	91155360	363	15.56
D240	91155240	243	10.72	D390	91155390	393	16.96
D248	91155248	251	10.99	D400	91155400	403	17.00
D250	91155250	255	11.26	D420	91155420	423	18.11
D255	91155255	260	11.50	D436	91155436	441	18.41
D258	91155258	263	11.80	D441	91155441	444	18.71
D260	91155260	265	12.10	D440	91155440	445	19.00
D270	91155270	273	12.40	D444	91155444	449	19.16
D282	91155282	287	12.70	D450	91155450	458	19.31
D285	91155285	290	13.00	D472	91155472	475	21.00
D300	91155300	303	13.30	D480	91155480	483	22.00
D310	91155310	315	13.60	D540	91155540	545	23.04

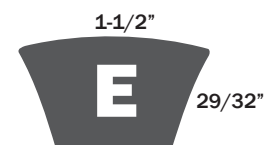
**BANDA HI-POWER®****SECCIÓN E**

DESCRIPCIÓN	CÓDIGO	LONG. (PULG.)	PESO (LBS.)	DESCRIPCIÓN	CÓDIGO	LONG. (PULG.)	PESO (LBS.)
E180	91166180	187	11.66	E300	91166300	304	18.53
E195	91166195	202	12.46	E330	91166330	334	19.53
E210	91166210	216	13.27	E350	91166350	354	20.53
E225	91166225	231	14.27	E360	91166360	364	21.44
E235	91166235	239	15.27	E390	91166390	394	23.05
E240	91166240	244	15.31	E420	91166420	424	24.75
E257	91166257	263	15.91	E440	91166440	445	25.45
E260	91166260	266	16.51	E441	91166441	445	26.15
E270	91166270	274	16.91	E470	91166470	476	26.85
E285	91166285	289	17.00	E480	91166480	484	27.89

BANDAS HI POWER® II

POWERBAND®

La construcción de PowerBand® permite a múltiples bandas funcionar como una sola, con una distribución uniforme de la carga en cada banda.

MERCADOS/APLICACIONES

Recomendada para transmisiones donde la vibración pudiera ser tan extrema que éstas pudieran voltearse o brincarse en la transmisión.

CARACTERÍSTICAS/VENTAJAS

- La cubierta asegura alta rigidez lateral, guiando a la banda en línea recta y previniendo salirse de la transmisión.
- Las paredes laterales cóncavas proporcionan soporte y máximo contacto con la ranura de la polea, con una distribución uniforme de la carga.
- Las Cuerdas Flex-Bonded® son fuertemente unidas al cuerpo de la banda, resultando en distribución uniforme de la carga y absorción del esfuerzo aún en poleas de diámetros pequeños.
- Satisface los estándares RMA de resistencia al petróleo y calor.
- Satisface los requerimientos RMA de conductividad estática.

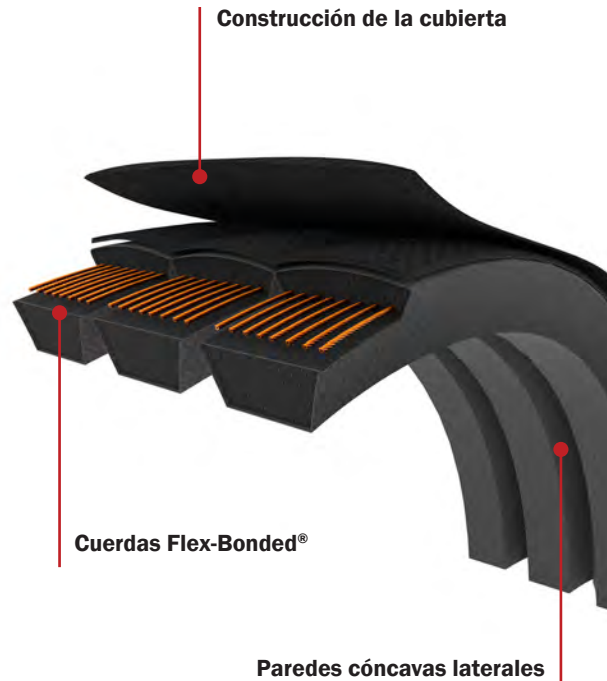

Poleas recomendadas: Poleas Multi-Duty (B, C, D)

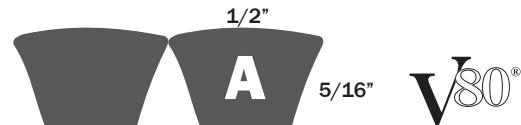

BANDA HI-POWER® II POWERBAND®

SECCIÓN A

BANDA (#=UNIDAS)	LONG. EXT (PULG.)	PESO/ BANDA (LBS.)	9092											13-20 BDAS.MÁX.
			2 BDAS.	3 BDAS.	4 BDAS.	5 BDAS.	6 BDAS.	7 BDAS.	8 BDAS.	9 BDAS.	10 BDAS.	11 BDAS.	12 BDAS.	
* #/A42	44.0	0.36	2042	3042	4042	5042	6042	7042	8042	9042	10042	11042	12042	##042
* #/A43	45.0	0.37	2043	3043	4043	5043	6043	7043	8043	9043	10043	11043	12043	##043
* #/A44	46.0	0.38	2044	3044	4044	5044	6044	7044	8044	9044	10044	11044	12044	##044
* #/A46	48.0	0.40	2046	3046	4046	5046	6046	7046	8046	9046	10046	11046	12046	##046
* #/A47	49.0	0.40	2047	3047	4047	5047	6047	7047	8047	9047	10047	11047	12047	##047
* #/A48	50.0	0.40	2048	3048	4048	5048	6048	7048	8048	9048	10048	11048	12048	##048
* #/A49	51.0	0.42	2049	3049	4049	5049	6049	7049	8049	9049	10049	11049	12049	##049
* #/A51	53.0	0.44	2051	3051	4051	5051	6051	7051	8051	9051	10051	11051	12051	##051

BANDA HI-POWER® II POWERBAND®**SECCIÓN A**

BANDA (#UNIDAS)	LONG. EXT (PULG.)	PESO/ BANDA (LBS.)	9092											13-20 BDAS. MÁX.
			2 BDAS.	3 BDAS.	4 BDAS.	5 BDAS.	6 BDAS.	7 BDAS.	8 BDAS.	9 BDAS.	10 BDAS.	11 BDAS.	12 BDAS.	
* #/A53	55.0	0.46	2053	3053	4053	5053	6053	7053	8053	9053	10053	11053	12053	##053
* #/A54	56.0	0.47	2054	3054	4054	5054	6054	7054	8054	9054	10054	11054	12054	##054
* #/A55	57.0	0.47	2055	3055	4055	5055	6055	7055	8055	9055	10055	11055	12055	##055
* #/A56	58.0	0.48	2056	3056	4056	5056	6056	7056	8056	9056	10056	11056	12056	##056
* #/A57	59.0	0.50	2057	3057	4057	5057	6057	7057	8057	9057	10057	11057	12057	##057
* #/A58	60.0	0.50	2058	3058	4058	5058	6058	7058	8058	9058	10058	11058	12058	##058
* #/A60	62.0	0.52	2060	3060	4060	5060	6060	7060	8060	9060	10060	11060	12060	##060
#/A62	64.0	0.54	2062	3062	4062	5062	6062	7062	8062	9062	10062	11062	12062	##062
#/A64	66.0	0.56	2064	3064	4064	5064	6064	7064	8064	9064	10064	11064	12064	##064
#/A65	67.0	0.56	2065	3065	4065	5065	6065	7065	8065	9065	10065	11065	12065	##065
#/A66	68.0	0.57	2066	3066	4066	5066	6066	7066	8066	9066	10066	11066	12066	##066
#/A68	70.0	0.58	2068	3068	4068	5068	6068	7068	8068	9068	10068	11068	12068	##068
#/A70	72.0	0.61	2070	3070	4070	5070	6070	7070	8070	9070	10070	11070	12070	##070
#/A71	73.0	0.61	2071	3071	4071	5071	6071	7071	8071	9071	10071	11071	12071	##071
#/A74	76.0	0.64	2074	3074	4074	5074	6074	7074	8074	9074	10074	11074	12074	##074
#/A75	77.0	0.66	2075	3075	4075	5075	6075	7075	8075	9075	10075	11075	12075	##075
#/A77	79.0	0.66	2077	3077	4077	5077	6077	7077	8077	9077	10077	11077	12077	##077
#/A78	80.0	0.67	2078	3078	4078	5078	6078	7078	8078	9078	10078	11078	12078	##078
#/A80	82.0	0.70	2080	3080	4080	5080	6080	7080	8080	9080	10080	11080	12080	##080
#/A81	83.0	0.70	2081	3081	4081	5081	6081	7081	8081	9081	10081	11081	12081	##081
#/A83	85.0	0.71	2083	3083	4083	5083	6083	7083	8083	9083	10083	11083	12083	##083
#/A85	87.0	0.74	2085	3085	4085	5085	6085	7085	8085	9085	10085	11085	12085	##085
#/A90	92.0	0.77	2090	3090	4090	5090	6090	7090	8090	9090	10090	11090	12090	##090
#/A92	94.0	0.80	2092	3092	4092	5092	6092	7092	8092	9092	10092	11092	12092	##092
#/A96	98.0	0.84	2096	3096	4096	5096	6096	7096	8096	9096	10096	11096	12096	##096
#/A100	102.0	0.86	2100	3100	4100	5100	6100	7100	8100	9100	10100	11100	12100	##100
#/A105	107.0	0.90	2105	3105	4105	5105	6105	7105	8105	9105	10105	11105	12105	##105
#/A110	112.0	0.96	2110	3110	4110	5110	6110	7110	8110	9110	10110	11110	12110	##110
#/A112	114.0	0.96	2112	3112	4112	5112	6112	7112	8112	9112	10112	11112	12112	##112
#/A120	122.0	1.04	2120	3120	4120	5120	6120	7120	8120	9120	10120	11120	12120	##120
#/A128	130.0	1.10	2128	3128	4128	5128	6128	7128	8128	9128	10128	11128	12128	##128
#/A136	138.0	1.17	2136	3136	4136	5136	6136	7136	8136	9136	10136	11136	12136	##136
#/A144	146.0	1.24	2144	3144	4144	5144	6144	7144	8144	9144	10144	11144	12144	##144
#/A158	160.0	1.36	2158	3158	4158	5158	6158	7158	8158	9158	10158	11158	12158	##158
#/A173	175.0	1.50	2173	3173	4173	5173	6173	7173	8173	9173	10173	11173	12173	##173
#/A180	182.0	1.56	2180	3180	4180	5180	6180	7180	8180	9180	10180	11180	12180	##180

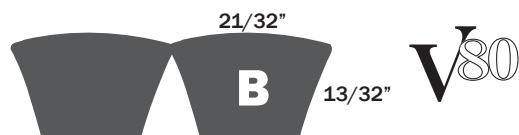

BANDA HI-POWER® II POWERBAND®

SECCIÓN B

BANDA (#=UNIDAS)	LONG. EXT. (PULG.)	PESO/ BANDA (LBS.)	9093											13-16 BDAS.MÁX.
			2 BDAS.	3 BDAS.	4 BDAS.	5 BDAS.	6 BDAS.	7 BDAS.	8 BDAS.	9 BDAS.	10 BDAS.	11 BDAS.	12 BDAS.	
#/B35	38.0	0.52	2035	3035	4035	5035	6035	7035	8035	9035	10035	11035	12035	##035
#/B38	41.0	0.56	2038	3038	4038	5038	6038	7038	8038	9038	10038	11038	12038	##038
#/B40	43.0	0.57	2040	3040	4040	5040	6040	7040	8040	9040	10040	11040	12040	##043
#/B41	44.0	0.58	2041	3041	4041	5041	6041	7041	8041	9041	10041	11041	12041	##041
#/B42	45.0	0.62	2042	3042	4042	5042	6042	7042	8042	9042	10042	11042	12042	##042
#/B43	46.0	0.64	2043	3043	4043	5043	6043	7043	8043	9043	10043	11043	12043	##043
#/B44	47.0	0.66	2044	3044	4044	5044	6044	7044	8044	9044	10044	11044	12044	##044
#/B46	49.0	0.68	2046	3046	4046	5046	6046	7046	8046	9046	10046	11046	12046	##046
#/B47	50.0	0.70	2047	3047	4047	5047	6047	7047	8047	9047	10047	11047	12047	##047
#/B48	51.0	0.71	2048	3048	4048	5048	6048	7048	8048	9048	10048	11048	12048	##048
#/B50	53.0	0.74	2050	3050	4050	5050	6050	7050	8050	9050	10050	11050	12050	##050
#/B52	55.0	0.77	2052	3052	4052	5052	6052	7052	8052	9052	10052	11052	12052	##052
#/B53	56.0	0.78	2053	3053	4053	5053	6053	7053	8053	9053	10053	11053	12053	##053
#/B54	57.0	0.80	2054	3054	4054	5054	6054	7054	8054	9054	10054	11054	12054	##054
#/B55	58.0	0.81	2055	3055	4055	5055	6055	7055	8055	9055	10055	11055	12055	##055
#/B56	59.0	0.84	2056	3056	4056	5056	6056	7056	8056	9056	10056	11056	12056	##056
#/B57	60.0	0.84	2057	3057	4057	5057	6057	7057	8057	9057	10057	11057	12057	##057
#/B58	61.0	0.86	2058	3058	4058	5058	6058	7058	8058	9058	10058	11058	12058	##058
#/B59	62.0	0.87	2059	3059	4059	5059	6059	7059	8059	9059	10059	11059	12059	##059
#/B60	63.0	0.90	2060	3060	4060	5060	6060	7060	8060	9060	10060	11060	12060	##060
1#/B61	64.0	0.90	2061	3061	4061	5061	6061	7061	8061	9061	10061	11061	12061	##061
#/B62	65.0	0.92	2062	3062	4062	5062	6062	7062	8062	9062	10062	11062	12062	##062
#/B63	66.0	0.94	2063	3063	4063	5063	6063	7063	8063	9063	10063	11063	12063	##063
#/B64	67.0	0.96	2064	3064	4064	5064	6064	7064	8064	9064	10064	11064	12064	##064
#/B65	68.0	0.96	2065	3065	4065	5065	6065	7065	8065	9065	10065	11065	12065	##065
#/B66	69.0	0.98	2066	3066	4066	5066	6066	7066	8066	9066	10066	11066	12066	##066
#/B67	70.0	1.00	2067	3067	4067	5067	6067	7067	8067	9067	10067	11067	12067	##067
#/B68	71.0	1.00	2068	3068	4068	5068	6068	7068	8068	9068	10068	11068	12068	##068
#/B70	73.0	1.04	2070	3070	4070	5070	6070	7070	8070	9070	10070	11070	12070	##070
#/B71	74.0	1.06	2071	3071	4071	5071	6071	7071	8071	9071	10071	11071	12071	##071
#/B72	75.0	1.06	2072	3072	4072	5072	6072	7072	8072	9072	10072	11072	12072	##072
#/B73	76.0	1.08	2073	3073	4073	5073	6073	7073	8073	9073	10073	11073	12073	##073
#/B74	77.0	1.10	2074	3074	4074	5074	6074	7074	8074	9074	10074	11074	12074	##074
#/B75	78.0	1.11	2075	3075	4075	5075	6075	7075	8075	9075	10075	11075	12075	##075

BANDAS HI-POWER® II
POWERBAND®



BANDA HI-POWER® II POWERBAND®

SECCIÓN C

BANDA (#=UNIDAS)	LONG. EXT (PULG.)	PESO/ BANDA (LBS.)	9094											
			2 BDAS	3 BDAS	4 BDAS	5 BDAS	6 BDAS	7 BDAS	8 BDAS	9 BDAS	10 BDAS	11 BDAS	12 BDAS	
#/C60	64.0	1.56	2060	3060	4060	5060	6060	7060	8060	9060	10060	11060	12060	
#/C68	72.0	1.77	2068	3068	4068	5068	6068	7068	8068	9068	10068	11068	12068	
#/C72	76.0	1.88	2072	3072	4072	5072	6072	7072	8072	9072	10072	11072	12072	
#/C75	79.0	1.96	2075	3075	4075	5075	6075	7075	8075	9075	10075	11075	12075	
#/C78	82.0	2.04	2078	3078	4078	5078	6078	7078	8078	9078	10078	11078	12078	
#/C80	84.0	2.09	2080	3080	4080	5080	6080	7080	8080	9080	10080	11080	12080	
#/C81	85.0	2.11	2081	3081	4081	5081	6081	7081	8081	9081	10081	11081	12081	
#/C85	89.0	2.21	2085	3085	4085	5085	6085	7085	8085	9085	10085	11085	12085	
#/C87	91.0	2.26	2087	3087	4087	5087	6087	7087	8087	9087	10087	11087	12087	
#/C90	94.0	2.34	2090	3090	4090	5090	6090	7090	8090	9090	10090	11090	12090	
#/C96	100.0	2.50	2096	3096	4096	5096	6096	7096	8096	9096	10096	11096	12096	
#/C99	103.0	2.57	2099	3099	4099	5099	6099	7099	8099	9099	10099	11099	12099	
#/C100	104.0	2.60	2100	3100	4100	5100	6100	7100	8100	9100	10100	11100	12100	
#/C105	109.0	2.74	2105	3105	4105	5105	6105	7105	8105	9105	10105	11105	12105	
#/C108	112.0	2.81	2108	3108	4108	5108	6108	7108	8108	9108	10108	11108	12108	
#/C109	113.0	2.84	2109	3109	4109	5109	6109	7109	8109	9109	10109	11109	12109	
#/C112	116.0	2.91	2112	3112	4112	5112	6112	7112	8112	9112	10112	11112	12112	
#/C120	124.0	3.12	2120	3120	4120	5120	6120	7120	8120	9120	10120	11120	12120	
#/C124	128.0	3.22	2124	3124	4124	5124	6124	7124	8124	9124	10124	11124	12124	
#/C126	130.0	3.28	2126	3126	4126	5126	6126	7126	8126	9126	10126	11126	12126	
#/C128	132.0	3.34	2128	3128	4128	5128	6128	7128	8128	9128	10128	11128	12128	
#/C136	140.0	3.54	2136	3136	4136	5136	6136	7136	8136	9136	10136	11136	12136	
#/C144	148.0	3.74	2144	3144	4144	5144	6144	7144	8144	9144	10144	11144	12144	
#/C146	150.0	3.79	2146	3146	4146	5146	6146	7146	8146	9146	10146	11146	12146	
#/C151	154.9	3.92	2151	3151	4151	5151	6151	7151	8151	9151	10151	11151	12151	
#/C158	162.0	4.11	2158	3158	4158	5158	6158	7158	8158	9158	10158	11158	12158	
#/C162	166.0	4.21	2162	3162	4162	5162	6162	7162	8162	9162	10162	11162	12162	
#/C173	177.0	4.50	2173	3173	4173	5173	6173	7173	8173	9173	10173	11173	12173	
#/C180	184.0	4.68	2180	3180	4180	5180	6180	7180	8180	9180	10180	11180	12180	
#/C185	189.0	4.88	2185	3185	4185	5185	6185	7185	8185	9185	10185	11185	12185	
#/C190	194.0	4.88	2190	3190	4190	5190	6190	7190	8190	9190	10190	11190	12190	
#/C195	199.0	5.07	2195	3195	4195	5195	6195	7195	8195	9195	10195	11195	12195	
#/C204	208.0	5.30	2204	3204	4204	5204	6204	7204	8204	9204	10204	11204	12204	
#/C210	214.0	5.46	2210	3210	4210	5210	6210	7210	8210	9210	10210	11210	12210	
#/C255	227.0	5.86	2225	3225	4225	5225	6225	7225	8225	9225	10225	11225	12225	
#/C240	242.0	6.24	2240	3240	4240	5240	6240	7240	8240	9240	10240	11240	12240	
#/C255	257.0	6.64	2255	3255	4255	5255	6255	7255	8255	9255	10255	11255	12255	
#/C270	272.0	7.02	2270	3270	4270	5270	6270	7270	8270	9270	10270	11270	12270	
#/C285	287.0	7.41	2285	3285	4285	5285	6285	7285	8285	9285	10285	11285	12285	

BANDAS HI POWER® II
POWERBAND®

BANDA HI-POWER® II POWERBAND®

SECCIÓN C

BANDA (#=UNIDAS)	LONG. EXT (PULG.)	PESO/ BANDA (LBS.)	9094										
			2 BDAS	3 BDAS	4 BDAS	5 BDAS	6 BDAS	7 BDAS	8 BDAS	9 BDAS	10 BDAS	11 BDAS	12 BDAS
#/C300	302.0	7.80	2300	3300	4300	5300	6300	7300	8300	9300	10300	11300	12300
#/C315	317.0	8.20	2315	3315	4315	5315	6315	7315	8315	9315	10315	11315	12315
#/C330	332.0	8.58	2330	3330	4330	5330	6330	7330	8330	9330	10330	11330	12330
#/C345	347.0	8.97	2345	3345	4345	5345	6345	7345	8345	9345	10345	11345	12345
#/C360	362.0	9.36	2360	3360	4360	5360	6360	7360	8360	9360	10360	11360	12360
#/C390	392.0	10.14	2390	3390	4390	5390	6390	7390	8390	9390	10390	11390	12390
#/C420	422.0	10.92	2420	3420	4420	5420	6420	7420	8420	9420	10420	11420	12420

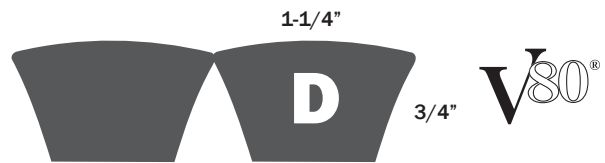

BANDA HI-POWER® II POWERBAND®

SECCIÓN D

BANDA (#=UNIDAS)	LONG. EXT (PULG.)	PESO/BANDA (LBS.)	9095							
			2 BANDAS	3 BANDAS	4 BANDAS	5 BANDAS	6 BANDAS	7 BANDAS	8 BANDAS	
#/D144	149.0	6.75	2144	3144	4144	5144	6144	7144	-	
#/D158	163.0	7.40	2158	3158	4158	5158	6158	7158	-	
#/D173	178.0	8.10	2173	3173	4173	5173	6173	7173	-	
#/D180	185.0	8.44	2180	3180	4180	5180	6180	7180	-	
#/D195	200.0	9.09	2195	3195	4195	5195	6195	7195	-	
#/D210	215.0	9.84	2210	3210	4210	5210	6210	7210	8210	
#/D225	228.0	10.56	2225	3225	4225	5225	6225	7225	8225	
#/D240	243.0	11.26	2240	3240	4240	5240	6240	7240	8240	
#/D255	258.0	11.96	2255	3255	4255	5255	6255	7255	8255	
#/D270	273.0	12.66	2270	3270	4270	5270	6270	7270	8270	
#/D285	288.0	13.37	2285	3285	4285	5285	6285	7285	8285	
#/D300	303.0	14.07	2300	3300	4300	5300	6300	7300	8300	
#/D315	318.0	14.77	2315	3315	4315	5315	6315	7315	8315	
#/D330	333.0	15.48	2330	3330	4330	5330	6330	7330	8330	
#/D345	348.0	16.18	2345	3345	4345	5345	6345	7345	8345	
#/D360	363.0	16.88	2360	3360	4360	5360	6360	7360	8360	
#/D390	393.0	18.29	2390	3390	4390	5390	6390	7390	8390	
#/D420	423.0	19.70	2420	3420	4420	5420	6420	7420	8420	
#/D450	453.0	21.10	2450	3450	4450	5450	6450	7450	8450	
#/D480	483.0	22.50	2480	3480	4480	5480	6480	7480	8480	
#/D540	543.0	25.33	2540	3540	4540	5540	6540	7540	8540	
#/D600	603.0	28.14	2600	3600	4600	5600	6600	7600	8600	
#/D660	663.0	31.13	2660	3660	4660	5660	6660	7660	8660	

BANDAS HI-POWER® II
POWERBAND®

BANDAS TRI-POWER®

Construida con materiales patentados por Gates, esta banda tiene una capacidad de flexión superior de carga, así como menor elongación y mínimo mantenimiento.

MERCADOS/APLICACIONES

La mejor opción para todo tipo de aplicaciones industriales, particularmente donde hay diámetros reducidos de poleas.

CARACTERÍSTICAS/VENTAJAS

- El dentado moldeado especial de la banda es la mejor opción para transmisiones con diámetros pequeños de poleas.
- El corte de la banda es maquinado para un contacto total con la ranura de la polea, lo que resulta en menor deslizamiento.
- Las cuerdas Flex-Bonded® están fuertemente unidas al cuerpo de la banda, resultando en una distribución uniforme de la carga y absorción del esfuerzo al circular por poleas de diámetros reducidos.
- Satisface los estándares RMA de resistencia al petróleo y calor.
- Satisface los requerimientos RMA de conductividad estática.



Poleas recomendadas: Poleas Multi-Duty.

Notas: Las bandas Tri Power® están disponibles en tamaños AX, BX y CX.



BANDA TRI-POWER®

SECCIÓN AX

DESCRIPCIÓN	CÓDIGO	LONG. (PULG.)	PESO (LBS.)	DESCRIPCIÓN	CÓDIGO	LONG. (PULG.)	PESO (LBS.)
AX22	90122022	24	0.16	AX34	90122034	36	0.26
AX23	90122023	25	0.17	AX35	90122035	37	0.27
AX24	90122024	26	0.17	AX36	90122036	38	0.27
AX25	90122025	27	0.18	AX37	90122037	39	0.28
AX26	90122026	28	0.19	AX38	90122038	40	0.29
AX27	90122027	29	0.20	AX39	90122039	41	0.29
AX28	90122028	30	0.20	AX40	90122040	42	0.30
AX29	90122029	31	0.21	AX41	90122041	43	0.30
AX30	90122030	32	0.22	AX42	90122042	44	0.31
AX31	90122031	33	0.22	AX43	90122043	45	0.32
AX32	90122032	34	0.25	AX44	90122044	46	0.32
AX33	90122033	35	0.26	AX45	90122045	47	0.33

BANDA TRI-POWER®**SECCIÓN AX**

DESCRIPCIÓN	CÓDIGO	LONG. (PULG.)	PESO (LBS.)	DESCRIPCIÓN	CÓDIGO	LONG. (PULG.)	PESO (LBS.)
AX46	90122046	48	0.33	AX76	90122076	78	0.49
AX47	90122047	49	0.34	AX77	90122077	79	0.49
AX48	90122048	50	0.35	AX78	90122078	80	0.49
AX49	90122049	51	0.35	AX79	90122079	81	0.50
AX50	90122050	52	0.36	AX80	90122080	82	0.50
AX51	90122051	53	0.36	AX81	90122081	83	0.51
AX52	90122052	54	0.36	AX82	90122082	84	0.52
AX53	90122053	55	0.36	AX83	90122083	85	0.53
AX54	90122054	56	0.36	AX84	90122084	86	0.54
AX55	90122055	57	0.37	AX85	90122085	87	0.54
AX56	90122056	58	0.37	AX86	90122086	88	0.55
AX57	90122057	59	0.38	AX87	90122087	89	0.56
AX58	90122058	60	0.38	AX88	90122088	90	0.56
AX59	90122059	61	0.39	AX89	90122089	91	0.57
AX60	90122060	62	0.39	AX90	90122090	92	0.57
AX61	90122061	63	0.40	AX91	90122091	93	0.57
AX62	90122062	64	0.41	AX92	90122092	94	0.57
AX63	90122063	65	0.41	AX93	90122093	95	0.58
AX64	90122064	66	0.42	AX94	90122094	96	0.59
AX65	90122065	67	0.42	AX96	90122096	98	0.60
AX66	90122066	68	0.43	AX97	90122097	99	0.61
AX67	90122067	69	0.44	AX98	90122098	100	0.62
AX68	90122068	70	0.44	AX103	90122103	105	0.63
AX69	90122069	71	0.45	AX105	90122105	107	0.64
AX70	90122070	72	0.45	AX110	90122110	112	0.65
AX71	90122071	73	0.46	AX112	90122112	114	0.66
AX72	90122072	74	0.47	AX120	90122120	122	0.74
AX73	90122073	75	0.47	AX128	90122128	130	0.75
AX74	90122074	76	0.48	AX144	90122144	146	0.91
AX75	90122075	77	0.48	AX173	90122173	175	1.13

BANDAS TRI-POWER®

**BANDA TRI-POWER®****SECCIÓN BX**

DESCRIPCIÓN	CÓDIGO	LONG. (PULG.)	PESO (LBS.)	DESCRIPCIÓN	CÓDIGO	LONG. (PULG.)	PESO (LBS.)
BX26	90132026	29	0.32	BX30	90132030	33	0.34
BX27	90132027	30	0.33	BX31	90132031	34	0.35
BX28	90132028	31	0.33	BX31	90132031	34	0.36
BX29	90132029	32	0.34	BX32	90132032	35	0.36

BANDA TRI-POWER®**SECCIÓN BX**

DESCRIPCIÓN	CÓDIGO	LONG. (PULG.)	PESO (LBS.)	DESCRIPCIÓN	CÓDIGO	LONG. (PULG.)	PESO (LBS.)
BX33	90132033	36	0.37	BX76	90132076	79	0.87
BX34	90132034	37	0.38	BX77	90132077	80	0.87
BX35	90132035	38	0.39	BX78	90132078	81	0.88
BX36	90132036	39	0.41	BX79	90132079	82	0.89
BX37	90132037	40	0.42	BX80	90132080	83	0.90
BX38	90132038	41	0.44	BX81	90132081	84	0.91
BX39	90132039	42	0.45	BX82	90132082	85	0.91
BX40	90132040	43	0.47	BX83	90132083	86	0.92
BX41	90132041	44	0.48	BX84	90132084	87	0.93
BX42	90132042	45	0.49	BX85	90132085	88	0.95
BX43	90132043	46	0.51	BX86	90132086	89	0.96
BX44	90132044	47	0.52	BX87	90132087	90	0.96
BX45	90132045	48	0.53	BX88	90132088	91	0.97
BX46	90132046	49	0.54	BX89	90132089	92	0.98
BX47	90132047	50	0.55	BX90	90132090	93	0.99
BX48	90132048	51	0.57	BX91	90132091	94	1.00
BX49	90132049	52	0.58	BX92	90132092	95	1.00
BX50	90132050	53	0.64	BX93	90132093	96	1.01
BX51	90132051	54	0.65	BX94	90132094	97	1.02
BX52	90132052	55	0.66	BX95	90132095	98	1.03
BX53	90132053	56	0.68	BX96	90132096	99	1.04
BX54	90132054	57	0.69	BX97	90132097	100	1.05
BX55	90132055	58	0.69	BX98	90132098	101	1.06
BX56	90132056	59	0.70	BX99	90132099	102	1.07
BX57	90132057	60	0.71	BX100	90132100	103	1.08
BX58	90132058	61	0.73	BX103	90132103	106	1.09
BX59	90132059	62	0.74	BX105	90132105	108	1.10
BX60	90132060	63	0.74	BX108	90132108	111	1.11
BX61	90132061	64	0.75	BX110	90132110	113	1.12
BX62	90132062	65	0.76	BX112	90132112	115	1.24
BX63	90132063	66	0.78	BX113	90132113	116	1.27
BX64	90132064	67	0.79	BX115	90132115	118	1.30
BX65	90132065	68	0.79	BX116	90132116	119	1.33
BX66	90132066	69	0.80	BX120	90132120	123	1.36
BX67	90132067	70	0.81	BX124	90132124	127	1.37
BX68	90132068	71	0.82	BX128	90132128	131	1.37
BX69	90132069	72	0.83	BX133	90132133	136	1.38
BX70	90132070	73	0.83	BX136	90132136	139	1.41
BX71	90132071	74	0.84	BX140	90132140	143	1.44
BX72	90132072	75	0.84	BX144	90132144	147	1.46
BX73	90132073	76	0.85	BX150	90132150	153	1.53
BX74	90132074	77	0.86	BX158	90132158	161	1.60
BX75	90132075	78	0.86	BX162	90132162	165	1.67

BANDA TRI-POWER®**SECCIÓN BX**

DESCRIPCIÓN	CÓDIGO	LONG. (PULG.)	PESO (LBS.)
BX173	90132173	176	1.74
BX180	90132180	183	1.77
BX195	90132195	198	1.84
BX205	90132205	208	1.91
BX210	90132210	213	1.98

DESCRIPCIÓN	CÓDIGO	LONG. (PULG.)	PESO (LBS.)
BX225	90132225	226	2.05
BX255	90132255	256	2.74
BX270	90132270	271	2.81
BX300	90132300	301	2.88

**BANDA TRI-POWER®****SECCIÓN CX**

DESCRIPCIÓN	CÓDIGO	LONG. (PULG.)	PESO (LBS.)
CX51	90142051	55	1.02
CX60	90142060	64	1.03
CX68	90142068	72	1.04
CX75	90142075	79	1.04
CX81	90142081	85	1.05
CX83	90142083	87	1.06
CX85	90142085	89	1.07
CX90	90142090	94	1.08
CX96	90142096	100	1.09
CX100	90142100	104	1.09
CX101	90142101	105	1.74
CX105	90142105	109	1.79
CX106	90142106	110	1.84
CX109	90142109	113	1.89
CX112	90142112	116	1.94
CX115	90142115	119	1.97
CX120	90142120	124	2.02
CX123	90142123	127	2.07
CX128	90142128	132	2.12

DESCRIPCIÓN	CÓDIGO	LONG. (PULG.)	PESO (LBS.)
CX133	90142133	137	2.26
CX136	90142136	140	2.31
CX144	90142144	148	2.43
CX150	90142150	154	2.55
CX158	90142158	162	2.67
CX162	90142162	166	2.74
CX173	90142173	177	2.92
CX180	90142180	184	3.04
CX187	90142187	191	3.16
CX190	90142190	194	3.28
CX195	90142195	199	3.40
CX210	90142210	214	3.53
CX225	90142225	227	5.33
CX240	90142240	242	5.64
CX255	90142255	257	5.95
CX270	90142270	272	6.26
CX300	90142300	302	6.88
CX330	90142330	332	6.90
CX360	90142360	362	8.55

BANDAS METRIC POWER® V

Estas bandas están fabricadas con los más altos estándares de calidad a nivel mundial. Las bandas Metric Power® están disponibles para transmisiones con medidas métricas.

MERCADOS/APLICACIONES

En todo tipo de industria textil, máquinas herramientas y alimentos.

CARACTERÍSTICAS/VENTAJAS

- La construcción patentada caracteriza una invencible combinación de doblarse y capacidad de transporte de carga, estiramiento reducido e increíble adhesión de las cuerdas.
- El dentado moldeado especial reduce térmico y estrés de doblamiento.
- Cuerdas Flex-Bonded® son fuertemente unidas al cuerpo de la banda resultando en igual distribución de carga y absorción de estrés de doblamiento sin deteriorar la cuerda.
- Satisface los estándares RMA de resistencia al petróleo y al calor.
- Satisface los requerimientos RMA de conductividad estática.

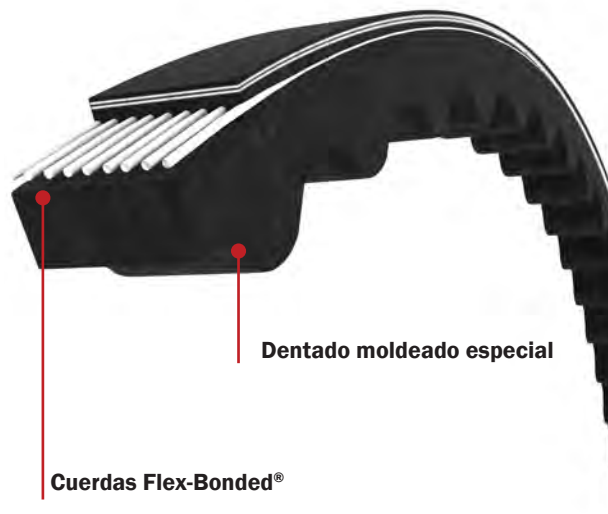

Poleas recomendadas: Contacte a su asesor de ventas Gates.

Notas: Las secciones incluyen: XPZ/SPZ, XPA/SPA, XPB/SPB, y XPC/SPC. Las clásicas secciones cruzadas incluyen 10X, 13X y 17X.



BANDA METRIC-POWER® V

SECCIÓN XPZ / SPZ

DENTADA	LISA	LONG. (MM.)	DENTADA	LISA	LONG (MM.)	DENTADA	LISA	LONG. (MM.)
	SPZ487	487	XPZ812	SPZ812	812	XPZ1112	SPZ1112	1112
	SPZ512	512	XPZ825	SPZ825	825	XPZ1120	SPZ1120	1120
XPZ560	SPZ560	560	XPZ837	SPZ837	837	XPZ1137	SPZ1137	1137
	SPZ587	587	XPZ850	SPZ850	850	XPZ1140		1140
XPZ600		600	XPZ862	SPZ862	862	XPZ1150	SPZ1150	1150
XPZ604		604	XPZ875	SPZ875	875	XPZ1162	SPZ1162	1162
XPZ612	SPZ612	612	XPZ887	SPZ887	887	XPZ1180	SPZ1180	1180
	SPZ615	615	XPZ900	SPZ900	900	XPZ1187	SPZ1187	1187
XPZ630	SPZ630	630	XPZ912	SPZ912	912	XPZ1200		1200
XPZ637	SPZ637	637	XPZ925	SPZ925	925	XPZ1202	SPZ1202	1202
XPZ640		640	XPZ937	SPZ937	937	XPZ1212	SPZ1212	1212
XPZ660		660	XPZ950	SPZ950	950	XPZ1210		1210

BANDA METRIC-POWER® V**SECCIÓN XPZ / SPZ**

DENTADA	LISA	LONG. (MM.)	DENTADA	LISA	LONG. (MM.)	DENTADA	LISA	LONG. (MM.)
XPZ1420		1420	XPZ1737	SPZ1737	1737	XPZ2160		2160
XPZ1430		1430	XPZ1750	SPZ1750	1750	XPZ2180	SPZ2180	2180
XPZ1437	SPZ1437	1437	XPZ1762	SPZ1762	1762	XPZ2187	SPZ2187	2187
XPZ1450	SPZ1450	1450	XPZ1782		1782	XPZ2240	SPZ2240	2240
XPZ1462	SPZ1462	1462	XPZ1787	SPZ1787	1787	XPZ2262		2262
XPZ1470		1470	XPZ1800	SPZ1800	1800	XPZ2280		2280
XPZ1487	SPZ1487	1487	XPZ1812	SPZ1812	1812	XPZ2287	SPZ2287	2287
XPZ1500	SPZ1500	1500	XPZ1837	SPZ1837	1837	XPZ2300		2300
XPZ1512	SPZ1512	1512	XPZ1850	SPZ1850	1850	XPZ2360	SPZ2360	2360
XPZ1520		1520	XPZ1862	SPZ1862	1862	XPZ2410		2410
XPZ1527		1527	XPZ1887	SPZ1887	1887	XPZ2430	SPZ2430	2430
XPZ1537	SPZ1537	1537	XPZ1900	SPZ1900	1900	XPZ2437		2437
XPZ1550	SPZ1550	1550	XPZ1937	SPZ1937	1937	XPZ2487		2487
XPZ1560		1560	XPZ1950	SPZ1950	1950	XPZ2500	SPZ2500	2500
XPZ1562	SPZ1562	1562	XPZ1962		1962	XPZ2540	SPZ2540	2540
	SPZ1575	1575	XPZ1987	SPZ1987	1987	XPZ2650	SPZ2650	2650
XPZ1587	SPZ1587	1587	XPZ2000	SPZ2000	2000	XPZ2690	SPZ2690	2690
XPZ1600	SPZ1600	1600	XPZ2030		2030	XPZ2800	SPZ2800	2800
XPZ1612	SPZ1612	1612	XPZ2037	SPZ2037	2037	XPZ2840	SPZ2840	2840
XPZ1637	SPZ1637	1637	XPZ2060	SPZ2060	2060	XPZ3000	SPZ3000	3000
XPZ1650	SPZ1650	1650	XPZ2062		2062	XPZ3150	SPZ3150	3150
XPZ1662	SPZ1662	1662	XPZ2087		2087	XPZ3350	SPZ3350	3350
XPZ1687	SPZ1687	1687	XPZ2120	SPZ2120	2120	XPZ3550	SPZ3550	3550
XPZ1700	SPZ1700	1700	XPZ2137	SPZ2137	2137		SPZ3750	3750
XPZ1712		1712	XPZ2150	SPZ2150	2150			

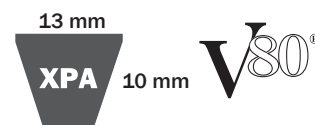
**BANDA METRIC-POWER® V****SECCIÓN XPA / SPA**

DENTADA	LISA	LONG. (MM.)	DENTADA	LISA	LONG. (MM.)	DENTADA	LISA	LONG. (MM.)
XPA630		630	XPA760		760	XPA850	SPA850	850
XPA670		670	XPA762		762	XPA857	SPA857	857
XPA 690		690	XPA772		772	XPA882	SPA882	882
XPA730		730	XPA782	SPA782	782	XPA900	SPA900	900
XPA732	SPA732	732	XPA800	SPA800	800	XPA907	SPA907	907
XPA747		747	XPA807	SPA807	807	XPA910		910
XPA750		750	XPA819		819	XPA922		922
XPA757	SPA757	757	XPA832	SPA832	832	XPA925	SPA925	925

BANDA METRIC-POWER® V**SECCIÓN XPA / SPA**

DENTADA	LISA	LONG. (MM.)	DENTADA	LISA	LONG. (MM.)	DENTADA	LISA	LONG. (MM.)
XPA932	SPA932	932	XPA1430		1430	XPA1950	SPA1950	1950
XPA950	SPA950	950	XPA1432	SPA1432	1432	XPA1957	SPA1957	1957
XPA957	SPA957	957	XPA1450	SPA1450	1450	XPA1982	SPA1982	1982
XPA975	SPA975	975	XPA1457	SPA1457	1457	XPA2000	SPA2000	2000
XPA982	SPA982	982	XPA1482	SPA1482	1482	XPA2032	SPA2032	2032
XPA1000	SPA1000	1000	XPA1500	SPA1500	1500	XPA2057	SPA2057	2057
XPA1007	SPA1007	1007	XPA1507	SPA1507	1507	XPA2060	SPA2060	2060
XPA1030	SPA1030	1030	XPA1525		1525	XPA2082	SPA2082	2082
XPA1032	SPA1032	1032	XPA1532	SPA1532	1532	XPA2120	SPA2120	2120
	SPA1057	1057	XPA1550	SPA1550	1550	XPA2132	SPA2132	2132
XPA1060	SPA1060	1060	XPA1557	SPA1557	1557	XPA2180	SPA2180	2180
XPA1082	SPA1082	1082	XPA1582	SPA1582	1582	XPA2182	SPA2182	2182
XPA1090	SPA1090	1090	XPA1600	SPA1600	1600	XPA2207	SPA2207	2207
XPA1107	SPA1107	1107	XPA1607	SPA1607	1607	XPA2227		2227
XPA1120	SPA1120	1120	XPA1630		1630	XPA2232	SPA2232	2232
XPA1132	SPA1132	1132	XPA1632	SPA1632	1632	XPA2240	SPA2240	2240
XPA1140		1140	XPA1650	SPA1650	1650	XPA2282	SPA2282	2282
XPA1150	SPA1150	1150	XPA1657	SPA1657	1657	XPA2300	SPA2300	2300
XPA1157	SPA1157	1157	XPA1662		1662	XPA2307	SPA2307	2307
XPA1180	SPA1180	1180	XPA1675		1675	XPA2332	SPA2332	2332
XPA1207	SPA1207	1207	XPA1680		1680	XPA2360	SPA2360	2360
XPA1215	SPA1215	1215	XPA1682	SPA1682	1682	XPA2382	SPA2382	2382
XPA1232	SPA1232	1232	XPA1700	SPA1700	1700	XPA2430	SPA2430	2430
XPA1250	SPA1250	1250	XPA1707	SPA1707	1707	XPA2432	SPA2432	2432
XPA1257	SPA1257	1257	XPA1732	SPA1732	1732	XPA2482	SPA2482	2482
XPA1272	SPA1272	1272	XPA1750	SPA1750	1750	XPA2500	SPA2500	2500
XPA1282	SPA1282	1282	XPA1757	SPA1757	1757	XPA2532	SPA2532	2532
XPA1285	SPA1285	1285	XPA1782	SPA1782	1782	XPA2582	SPA2582	2582
XPA1300		1300	XPA1800	SPA1800	1800	XPA2607	SPA2607	2607
XPA1307	SPA1307	1307	XPA1707	SPA1707	1707	XPA2632	SPA2632	2632
XPA1320	SPA1320	1320	XPA1732	SPA1732	1732	XPA2650	SPA2650	2650
XPA1332	SPA1332	1332	XPA1750	SPA1750	1750	XPA2682	SPA2682	2682
XPA1340		1340	XPA1757	SPA1757	1757		SPA2732	2732
XPA1357	SPA1357	1357	XPA1782	SPA1782	1782	XPA2782	SPA2782	2782
XPA1360	SPA1360	1360	XPA1800	SPA1800	1800	XPA2800	SPA2800	2800
XPA1382	SPA1382	1382	XPA1807	SPA1807	1807	XPA2832	SPA2832	2832
XPA1357		1357	XPA1832	SPA1832	1832		SPA2872	2872
XPA1360		1360	XPA1850	SPA1850	1850	XPA2882	SPA2882	2882
XPA1375		1375	XPA1857	SPA1857	1857	XPA2900	SPA2900	2900
XPA1382		1382	XPA1882	SPA1882	1882	XPA2932	SPA2932	2932
XPA1400	SPA1400	1400	XPA1900	SPA1900	1900	XPA2982	SPA2982	2982
XPA1407	SPA1407	1407	XPA1907	SPA1907	1907	XPA3000	SPA3000	3000
XPA1425		1425	XPA1932	SPA1932	1932		SPA3032	3032

BANDA METRIC-POWER® V**SECCIÓN XPA / SPA**

DENTADA	LISA	LONG. (MM.)
	SPA3070	3070
	SPA3082	3082
XPA3150	SPA3150	3150
	SPA3182	3182
	SPA3282	3282
XPA3350	SPA3350	3350
	SPA3382	3382
	SPA3482	3482
XPA3550	SPA3550	3550
	SPA3382	3650
XPA3750	SPA3750	3750
XPA4000	SPA4000	4000
	SPA4250	4250
	SPA4500	4500
	SPA5000	5000

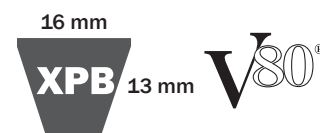
**BANDA METRIC-POWER® V****SECCIÓN XPB**

DENTADA	LISA	LONG. (MM.)	DENTADA	LISA	LONG. (MM.)	DENTADA	LISA	LONG. (MM.)
XPB1000		1000	XPB1750	SPB1750	1750	XPB2410		2410
XPB1060		1060		SPB1778	1778	XPB2500	SPB2500	2500
XPB1080		1080	XPB1800	SPB1800	1800	XPB2530		2530
XPB1120		1120	XPB1850	SPB1850	1850		SPB2600	2600
XPB1180		1180		SPB1860	1860	XPB2650	SPB2650	2650
XPB1250	SPB1250	1250	XPB1900	SPB1900	1900		SPB2680	2680
XPB1260		1260		SPB1930	1930	XPB2800	SPB2800	2800
XPB1320	SPB1320	1320	XPB1950	SPB1950	1950	XPB2840	SPB2840	2840
XPB1340		1340	XPB2000	SPB2000	2000		SPB2850	2850
	SPB1360	1360	XPB2020	SPB2020	2020	XPB2900	SPB2900	2900
XPB1400	SPB1400	1400		SPB2060	2060	XPB2990		2990
XPB1410		1410		SPB2098	2098	XPB3150	SPB3150	3150
XPB1450	SPB1450	1450	XPB2120	SPB2120	2120		SPB3250	3250
XPB1500	SPB1500	1500	XPB2150	SPB2150	2150	XPB3320	SPB3320	3320
XPB1510		1510		SPB2180	2180	XPB3350	SPB3350	3350
XPB1550	SPB1550	1550		SPB2200	2200	XPB3440		
XPB1590		1590	XPB2240	SPB2240	2240		SPB3450	3450
XPB1600	SPB1600	1600	XPB2280	SPB2280	2280	XPB3550	SPB3550	3550
XPB1627		1627	XPB2300	SPB2300	2300		SPB3650	3650
XPB1650	SPB1650	1650	XPB2360	SPB2360	2360	XPB3750	SPB3750	3750
XPB1690		1690		SPB2391	2391		SPB3800	3800
XPB1700	SPB1700	1700		SPB2400	2400		SPB3870	3870

BANDA METRIC-POWER® V**SECCIÓN XPB**

DENTADA	LISA	LONG. (MM.)	DENTADA	LISA	LONG. (MM.)
	SPB4120	4120		SPB5600	5600
XPB4250	SPB4250	4250		SPB6000	6000
XPB4500	SPB4500	4500		SPB6300	6300
XPB4750	SPB4750	4750		SPB6700	6700
	SPB4820	4820		SPB7100	7100
	SPB4870	4870		SPB7500	7500
XPB5000	SPB5000	5000		SPB8000	8000
	SPB5300	5300			

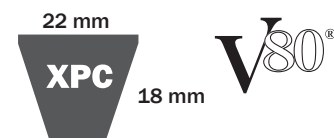
**BANDA METRIC-POWER® V****SECCIÓN XPC / SPC**

DENTADA	LISA	LONG. (MM.)	DENTADA	LISA	LONG. (MM.)	DENTADA	LISA	LONG. (MM.)
XPC1800		1800		SPC4100	4100		SPC9000	9000
XPC1900		1900	XPC4250	SPC4250	4250		SPC9500	9500
XPC2000	SPC2000	2000	XPC4500	SPC4500	4500		SPC10000	10000
XPC2120	SPC2120	2120	XPC4750	SPC4750	4750		SPC10600	10600
XPC2240	SPC2240	2240	XPC5000	SPC5000	5000		SPC11200	11200
XPC2360		2360		SPC5300	5300		SPC11800	11800
XPC2500	SPC2500	2500		SPC5600	5600		SPC12000	12000
	SPC2550	2550		SPC5800	5800		SPC12500	12500
XPC2650	SPC2650	2650		SPC6000	6000		SPC13500	13500
XPC2800	SPC2800	2800		SPC6300	6300		SPC13800	13800
XPC3000	SPC3000	3000		SPC6500	6500		SPC14200	14200
XPC3150	SPC3150	3150		SPC6700	6700		SPC15000	15000
XPC3350	SPC3350	3350		SPC7100	7100		SPC16500	16500
XPC3550	SPC3550	3550		SPC7500	7500			
XPC3750	SPC3750	3750		SPC8000	8000			
XPC4000	SPC4000	4000		SPC8500	8500			

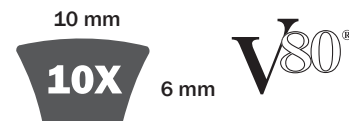
**BANDA METRIC-POWER®****SECCIÓN 10X**

DESCRIPCIÓN	CÓDIGO	DESCRIPCIÓN	CÓDIGO	DESCRIPCIÓN	CÓDIGO	DESCRIPCIÓN	CÓDIGO
10X530LI	942410530	10X750LI	942410750	10X950LI	942410950	10X1120LI	942410112
10X540LI	942410540	10X775LI	942410775	10X975LI	942410975	10X1180LI	942410118
10X670LI	942410670	10X800LI	942410800	10X1000LI	942410100	10X1400LI	942410140
10X710LI	942410710	10X875LI	942410875	10X1016LI	942410101	10X1422LI	942410142
10X725LI	942410725	10X900LI	942410900	10X1060LI	942410106	10X1750LI	942410175
10X730LI	942410730	10X925LI	942410925	10X1100LI	942410110		

**BANDA METRIC-POWER® V****Sección 13X**

DESCRIPCIÓN	CÓDIGO	DESCRIPCIÓN	CÓDIGO	DESCRIPCIÓN	CÓDIGO	DESCRIPCIÓN	CÓDIGO
13X715LI	942413715	13X813LI	942413813	13X975LI	942413975	13X4000LI	942313400
13X750LI	942413750	13X925LI	942413925	13X2650LI	942413265		

**BANDA METRIC-POWER® V****Sección 17X**

DESCRIPCIÓN	CÓDIGO	DESCRIPCIÓN	CÓDIGO	DESCRIPCIÓN	CÓDIGO	DESCRIPCIÓN	CÓDIGO
17X875LI	942417875	17X1800LI	942417180	17X2540LI	942417254	17X8375LI	942317837
17X1500LI	942417150	17X2160LI	942417216	17X3658LI	942317365	17X8636LI	942317863
17X1525LI	942417152	17X2240LI	942417224				

BANDAS HI POWER® II DOBLE V

Esta banda está diseñada con un único tope suspendido por la parte inferior para mantener las paredes en contacto, quedando flexible para transmisiones que requieren transmisión de potencia de ambos lados de la banda.

MERCADOS/APLICACIONES

La mejor opción para todas las aplicaciones industriales de serpentín requiriendo rotación en algunas flechas de transmisión.

CARACTERÍSTICAS/VENTAJAS

- La curvatura Gates proporciona soporte en la cuerda y máximo contacto con la ranura de la polea para carga uniforme y larga vida útil de la banda.
- Cuerdas Flex-Bonded® están fuertemente unidas al cuerpo de la banda, resultando en una distribución uniforme de la carga y de absorción de los esfuerzos o doblamiento sin deterioro de la banda.
- La Cubierta Flex-Weave® es una construcción patentada para más larga vida de la cubierta, proporcionando protección extendida a la banda, del petróleo, polvo y calor.
- Satisface los estándares RMA de resistencia al petróleo y calor.
- Satisface los requerimientos RMA de conductividad estática.

Poleas recomendadas: Poleas Multi-Duty.

Notas: Las bandas Doble V están disponibles en AA, BB, CC y DD.

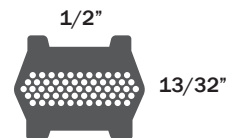

BANDA HI-POWER® II DOBLE V

SECCIÓN AA

DESCRIPCIÓN	CÓDIGO	LONG. (PULG.)	PESO (LBS.)	DESCRIPCIÓN	CÓDIGO	LONG. (PULG.)	PESO (LBS.)
AA51	90520051	53	0.46	AA66	90520066	68	0.55
AA55	90520055	57	0.49	AA68	90520068	70	0.55
AA60	90520060	62	0.51	AA70	90520070	72	0.56
AA62	90520062	64	0.53	AA73	90520073	75	0.58
AA64	90520064	66	0.53	AA75	90520075	77	0.6

BANDA HI-POWER® II DOBLE V**SECCIÓN AA**

DESCRIPCIÓN	CÓDIGO	LONG. (PULG.)	PESO (LBS.)	DESCRIPCIÓN	CÓDIGO	LONG. (PULG.)	PESO (LBS.)
AA78	90520078	80	0.63	AA96	90520096	98	0.77
AA80	90520080	82	0.65	AA105	90520105	107	0.85
AA85	90520085	87	0.68	AA112	90520112	114	0.9
AA88	90520088	90	0.7	AA120	90520120	122	0.98
AA90	90520090	92	0.72	AA128	90520128	130	1.05
AA92	90520092	94	0.75	AA148	90520148	150	1.24

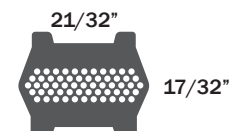
**BANDA HI-POWER® II DOBLE V****SECCIÓN BB**

DESCRIPCIÓN	CÓDIGO	LONG. (PULG.)	PESO (LBS.)	DESCRIPCIÓN	CÓDIGO	LONG. (PULG.)	PESO (LBS.)
BB35	90530035	38	0.6	BB100	90530100	103	1.35
BB38	90530038	41	0.63	BB103	90530103	106	1.4
BB42	90530042	45	0.65	BB105	90530105	108	1.43
BB43	90530043	46	0.67	BB107	90530107	110	1.48
BB45	90530045	48	0.71	BB108	90530108	111	1.49
BB46	90530046	49	0.73	BB111	90530111	114	1.5
BB51	90530051	54	0.75	BB112	90530112	115	1.51
BB53	90530053	56	0.78	BB114	90530114	117	1.53
BB55	90530055	58	0.81	BB116	90530116	119	1.57
BB60	90530060	63	0.86	BB117	90530117	120	1.59
BB64	90530064	67	0.9	BB118	90530118	121	1.61
BB66	90530066	69	0.92	BB120	90530120	123	1.63
BB68	90530068	71	0.94	BB122	90530122	125	1.65
BB71	90530071	74	0.98	BB123	90530123	126	1.67
BB72	90530072	75	1.01	BB124	90530124	127	1.69
BB73	90530073	76	1.02	BB127	90530127	130	1.71
BB74	90530074	77	1.04	BB128	90530128	131	1.73
BB75	90530075	78	1.05	BB129	90530129	132	1.75
BB81	90530081	84	1.12	BB130	90530130	133	1.79
BB83	90530083	86	1.16	BB133	90530133	136	1.83
BB85	90530085	88	1.18	BB135	90530035	138	1.86
BB90	90530090	93	1.2	BB136	90530036	139	1.9
BB92	90530092	95	1.22	BB140	90530040	143	1.95
BB93	90530093	96	1.24	BB144	90530044	147	1.98
BB94	90530094	97	1.26	BB155	90530055	158	2.13
BB96	90530096	99	1.3	BB158	90530058	165	2.16
BB97	90530097	100	1.32	BB162	90530162	171	2.2

BANDA HI-POWER® II DOBLE V**SECCIÓN BB**

DESCRIPCIÓN	CÓDIGO	LONG. (PULG.)	PESO (LBS.)	DESCRIPCIÓN	CÓDIGO	LONG. (PULG.)	PESO (LBS.)
BB168	90530168	171	2.22	BB225	90530225	226	3.08
BB169	90530169	172	2.24	BB226	90530226	227	3.1
BB170	90530170	173	2.26	BB228	90530228	229	3.12
BB173	90530173	176	2.31	BB230	90530230	231	3.15
BB180	90530180	183	2.35	BB240	90530240	241	3.38
BB182	90530182	185	2.4	BB255	90530255	256	3.6
BB187	90530187	190	2.5	BB270	90530270	271	3.85
BB190	90530190	193	2.56	BB277	90530277	278	3.95
BB195	90530195	196	2.66	BB285	90530285	286	4.05
BB210	90530210	213	2.86	BB300	90530300	301	4.34

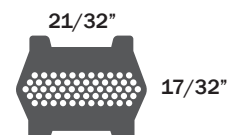
**BANDA HI-POWER® II DOBLE V****SECCIÓN CC**

DESCRIPCIÓN	CÓDIGO	LONG. (PULG.)	PESO (LBS.)	DESCRIPCIÓN	CÓDIGO	LONG. (PULG.)	PESO (LBS.)
CC75	90540075	79	1.85	CC162	90540162	166	4.05
CC81	90540081	85	1.95	CC173	90540173	177	4.4
CC85	90540085	89	2.05	CC180	90540180	184	4.5
CC90	90540090	94	2.15	CC195	90540195	199	5
CC96	90540096	100	2.35	CC210	90540210	214	5.4
CC105	90540105	109	2.5	CC240	90540240	244	6.1
CC112	90540012	16	2.7	CC255	90540255	259	6.4
CC120	90540020	24	3	CC270	90540270	274	6.8
CC128	90540028	32	3.17	CC300	90540300	304	8.1
CC1136	90540036	40	3.4	CC330	90540330	334	8.4
CC140	90540040	44	3.5	CC360	90540360	364	9.2
CC1144	90540044	48	3.6	CC390	90540390	394	9.9
CC158	90540058	62	3.95	CC400	90540400	404	10.7

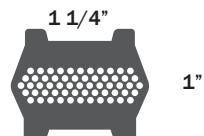
**BANDA HI-POWER® II DOBLE V****SECCIÓN DD**

DESCRIPCIÓN	CÓDIGO	LONG. (PULG.)	PESO (LBS.)
DD270	90550270	273	15.2
DD300	90550300	303	16.35
DD360	90550360	363	19.15

BANDAS MICRO V®

El exclusivo perfil truncado (sin punta) proporciona a las bandas Gates Micro V® una flexibilidad superior, reduce la generación de calor, alto desempeño a altas velocidades aún en diámetros de poleas pequeñas.

MERCADOS/APLICACIONES

El mejor producto para aplicaciones rudas y medianas como mecanismos de puertas, transportadoras de rodillo, máquinas herramienta, equipos médicos, equipo de ejercicio, etc.

CARACTERÍSTICAS/VENTAJAS

- Costillas con fibra para máxima resistencia en uso rudo.
- Alta carga, bajo estiramiento de cuerdas, potencia y confiabilidad.
- Operación uniforme para mínima vibración aún a alta velocidad.
- Satisface los estándares RMA de resistencia al petróleo y calor.
- Satisface los requerimientos RMA de conductividad estática.

Poleas recomendadas: Poleas Taper-Lock Micro V®.



Notas: Los números de parte están constituidos usando la longitud efectiva en décimas de una pulgada, seguido por una sección cruzada y el número de costillas. Por ejemplo, 780L16 representa una banda de 78" de longitud efectiva, L sección cruzada y 16 costillas. Otra configuración de costillas no será de stock estándar y puede requerir tiempo de entrega de manufactura. No es requerido ordenar una cantidad mínima en longitudes listadas.

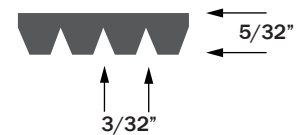

BANDA MICRO-V®

SECCIÓN J

BANDA (#=UNIDAS)	LONG. EFECT. (PULG.)	PESO/COSTILLA (LBS.)	9171						MÁXIMO NO. COSTILLAS
			4 COSTILLAS	6 COSTILLAS	8 COSTILLAS	10 COSTILLAS	16 COSTILLAS	20 COSTILLAS	
180J	18	0.01	917101804	917101806	917101808	917101810	917101816	917101820	30
190J	19	0.01	917101904	917101906	917101908	917101910	917101916	917101920	30
200J	20	0.01	917102004	917102006	917102008	917102010	917102016	917102020	30
220J	22	0.01	917102204	917102206	917102208	917102210	917102216	917102220	211
230J	23	0.01	917102304	917102306	917102308	917102310	917102316	917102320	211
240J	24	0.01	917102404	917102406	917102408	917102410	917102416	917102420	211
260J	26	0.01	917102604	917102606	917102608	917102610	917102616	917102620	211
280J	28	0.01	917102804	917102806	917102808	917102810	917102816	917102820	211
290J	29	0.01	917102904	917102906	917102908	917102910	917102916	917102920	211
300J	30	0.01	917103004	917103006	917103008	917103010	917103016	917103020	211
320J	32	0.02	917103204	917103206	917103208	917103210	917103216	917103220	211

BANDA MICRO-V®

SECCIÓN J

BANDA (#=UNIDAS)	LONG. EFFECT. (PULG.)	PESO/ COSTILLA (LBS.)	9171						MÁXIMO NO. COSTILLAS
			4 COSTILLAS	6 COSTILLAS	8 COSTILLAS	10 COSTILLAS	16 COSTILLAS	20 COSTILLAS	
330J	33	0.02	917103304	917103306	917103308	917103310	917103316	917103320	211
340J	34	0.02	917103404	917103406	917103408	917103410	917103416	917103420	211
360J	36	0.02	917103604	917103606	917103608	917103610	917103616	917103620	211
380J	38	0.02	916103804	917103806	917103808	917103810	917103816	917103820	211
400J	40	0.02	916104004	917104006	917104008	917104010	917104016	917104020	211
410J	41	0.02	916104104	917104106	917104108	917104110	917104116	917104120	211
420J	42	0.02	916104204	917104206	917104208	917104210	917104216	917104220	211
430J	43	0.02	916104304	917104306	917104308	917104310	917104316	917104320	211
440J	44	0.02	916104404	917104406	917104408	917104410	917104416	917104420	211
460J	46	0.02	916104604	917104606	917104608	917104610	917104616	917104620	211
480J	48	0.02	916104804	917104806	917104808	917104810	917104816	917104820	211
490J	49	0.02	916104904	917104906	917104908	917104910	917104916	917104920	211
500J	50	0.02	916105004	917105006	917105008	917105010	917105016	917105020	211
520J	52	0.02	916105204	917105206	917105208	917105210	917105216	917105220	211
550J	55	0.03	916105504	917105506	917105508	917105510	917105516	917105520	211
580J	58	0.03	916105804	917105806	917105808	917105810	917105816	917105820	211
610J	61	0.03	916106104	917106106	917106108	917106110	917106116	917106120	211
650J	65	0.03	916106504	917106506	917106508	917106510	917106516	917106520	211
650J	65	0.03	916106504	917106506	917106508	917106510	917106516	917106520	211
730J	73	0.03	916107304	917107306	917107308	917107310	917107316	917107320	211
870J	87	0.04	916108704	917108706	917108708	917108710	917108716	917108720	211
920J	92	0.04	916109204	917109206	917109208	917109210	-	-	10
980J	98	0.05	916109804	917109806	917109808	917109810	-	-	10

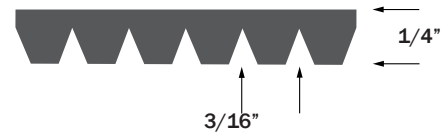

BANDA MICRO-V®

SECCIÓN L

BANDA (#=UNIDAS)	LONG. EFFECT. (PULG.)	PESO/ COSTILLAS (LBS.)	9171								MÁX.NO. COSTILLAS
			6 COSTILLAS	8 COSTILLAS	10 COSTILLAS	12 COSTILLAS	14 COSTILLAS	16 COSTILLAS	18 COSTILLAS	20 COSTILLAS	
500L	50	0.09	917305006	917305008	917305010	917305012	917305014	917305016	917305018	917305020	105
540L	54	0.09	917305406	917305408	917305410	917305412	917305414	917305416	917305418	917305420	105
560L	56	0.1	917305606	917305608	917305610	917305612	917305614	917305616	917305618	917305620	105
615L	61.5	0.11	917306106	917306108	917306110	917306112	917306114	917306116	917306118	917306120	105
635L	63.5	0.11	917306306	917306308	917306310	917306312	917306314	917306316	917306318	917306320	105
655L	65.5	0.11	917306506	917306508	917306510	917306512	917306514	917306516	917306518	917306520	105
675L	67.5	0.12	917306706	917306708	917306710	917306712	917306714	917306716	917306718	917306720	105
695L	69.5	0.12	917306906	917306908	917306910	917306912	917306914	917306916	917306918	917306920	105

BANDAS MICRO V®

BANDA MICRO-V®

SECCIÓN L

BANDA (#=UNIDAS)	LONG. EFECT. (PULG.)	PESO/COSTILLAS (LBS.)	9171								MÁX.NO. COSTILLAS
			6 COSTILLAS	8 COSTILLAS	10 COSTILLAS	12 COSTILLAS	14 COSTILLAS	16 COSTILLAS	18 COSTILLAS	20 COSTILLAS	
725L	72.5	0.13	917307206	917307208	917307210	917307212	917307214	917307216	917307218	917307220	105
765L	76.5	0.13	917307606	917307608	917307610	917307612	917307614	917307616	917307618	917307620	105
780L	78	0.14	917307806	917307808	917307810	917307812	917307814	917307816	917307818	917307820	105
795L	79.5	0.14	917307906	917307908	917307910	917307912	917307914	917307916	917307918	917307920	105
815L	81.5	0.14	917308106	917308108	917308110	917308112	917308114	917308116	917308118	917308120	105
840L	84	0.15	917308406	917308408	917308410	917308412	917308414	917308416	917308418	917308420	105
865L	86.5	0.15	917308606	917308608	917308610	917308612	917308614	917308616	917308618	917308620	105
915L	91.5	0.16	917309106	917309108	917309110	917309112	917309114	917309116	917309118	917309120	60
975L	97.5	0.17	917309706	917309708	917309710	917309712	917309714	917309716	917309718	917309720	60
990L	99	0.17	917309906	917309908	917309910	917309912	917309914	917309916	917309918	917309920	60
1065L	106.5	0.18	917310606	917310608	917310610	917310612	917310614	917310616	917310618	917310620	60
1120L	112	0.19	917311206	917311208	917311210	917311212	917311214	917311216	917311218	917311220	60
1150L	115	0.2	917311506	917311508	917311510	917311512	917311514	917311516	917311518	917311520	60
1215L	121.5	0.2	917312106	917312108	917312110	917312112	917312114	917312116	917312118	917312120	60
1230L	123	0.21	917312306	917312308	917312310	917312312	917312314	917312316	917312318	917312320	60
1295L	129.5	0.22	917312906	917312908	917312910	917312912	917312914	917312916	917312918	917312920	60
1310L	131	0.23	917313106	917313108	917313110	917313112	917313114	917313116	917313118	917313120	60
1455L	145.5	0.25	917314506	917314508	917314510	917314512	917314514	917314516	917314518	917314520	60

BANDAS MICRO-V®

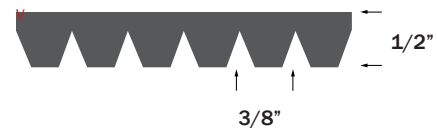

BANDA MICRO-V®

SECCIÓN M

BANDA (#=UNIDAS)	LONG. EFECT. (PULG.)	PESO/COSTILLA (LBS.)	9174								MÁX.NO. COSTILLAS
			6 COSTILLAS	8 COSTILLAS	10 COSTILLAS	12 COSTILLAS	14 COSTILLAS	16 COSTILLAS	18 COSTILLAS	20 COSTILLAS	
900M	90	0.63	917409006	917409008	917409010	917409012	917409014	917409016	917409018	917409020	30
940M	94	0.65	917409406	917409408	917409410	917409412	917409414	917409416	917409418	917409420	30
990M	99	0.69	917409906	917409908	917409910	917409912	917409914	917409916	917409918	917409920	30
1060M	106	0.74	917410606	917410608	917410610	917410612	917410614	917410616	917410618	917410620	30
1115M	111.5	0.78	917411106	917411108	917411110	917411112	917411114	917411116	917411118	917411120	30
1150M	115	0.8	917411506	917411508	917411510	917411512	917411514	917411516	917411518	917411520	30
1185M	118.5	0.82	917411806	917411808	917411810	917411812	917411814	917411816	917411818	917411820	30
1230M	123	0.86	917412306	917412308	917412310	917412312	917412314	917412316	917412318	917412320	30
1310M	131	0.91	917413106	917413108	917413110	917413112	917413114	917413116	917413118	917413120	30
1390M	139	0.97	917413906	917413908	917413910	917413912	917413914	917413916	917413918	917413920	30
1470M	147	1.02	917414706	917414708	917414710	917414712	917414714	917414716	917414718	917414720	30
						917416112	917416114	917416116	917416118	917416120	30
1650M	165	1.15	917416506	917416508	917416510	917416512	917416514	917416516	917416518	917416520	30
1760M	176	1.22	917417606	917417608	917417610	917417612	917417614	917417616	917417618	917417620	30
1830M	183	1.27	917418306	917418308	917418310	917418312	917418314	917418316	917418318	917418320	30

BANDA MICRO-V®

SECCIÓN M

BANDA (#-UNIDAS)	LONG. EFECT. (PULG.)	PESO/ COSTILLA (LBS.)	9174								MÁX.NO. COSTILLAS
			6 COSTILLAS	8 COSTILLAS	10 COSTILLAS	12 COSTILLAS	14 COSTILLAS	16 COSTILLAS	18 COSTILLAS	20 COSTILLAS	
1980M	198	1.38	917419806	917419808	917419810	917419812	917419814	917419816	917419818	917419820	30
2130M	213	1.48	917421306	917421308	917421310	917421312	917421314	917421316	917421318	917421320	30
2410M	241	1.68	917424106	917424108	917424110	917424112	917424114	917424116	917424118	917424120	30
2560M	256	1.78	917425606	917425608	917425610	917425612	917425614	917425616	917425618	917425620	30
2710M	271	1.88	917427106	917427108	917427110	917427112	917427114	917427116	917427118	917427120	30
3010M	301	2.09	917430106	917430108	917430110	917430112	917430114	917430116	917430118	917430120	30
3310M	331	2.3	917433106	917433108	917433110	917433112	917433114	917433116	917433118	917433120	30
3610M	361	2.51	917436106	917436108	917436110	917436112	917436114	917436116	917436118	917436120	30

BANDAS MICRO V®

BANDAS VELOCIDAD VARIABLE

Las bandas de Velocidad Variable RVS poseen la construcción más avanzada que le proporciona alta capacidad de carga, fibra de refuerzo en el cuerpo de la banda para mayor rigidez transversal con flexibilidad adecuada. Esta construcción ofrece mayor vida útil.

MERCADOS/APLICACIONES

La mejor opción para todo tipo de industria, en amplios rangos de velocidad y todo tipo de poleas para velocidad variable.

CARACTERÍSTICAS/VENTAJAS

- Diseño dentado reduce temperatura y estrés de doblamiento para vida más larga.
- Construcción uniforme para mínima vibración a altas velocidades.
- Satisface los estándares RMA de resistencia al petróleo y calor.

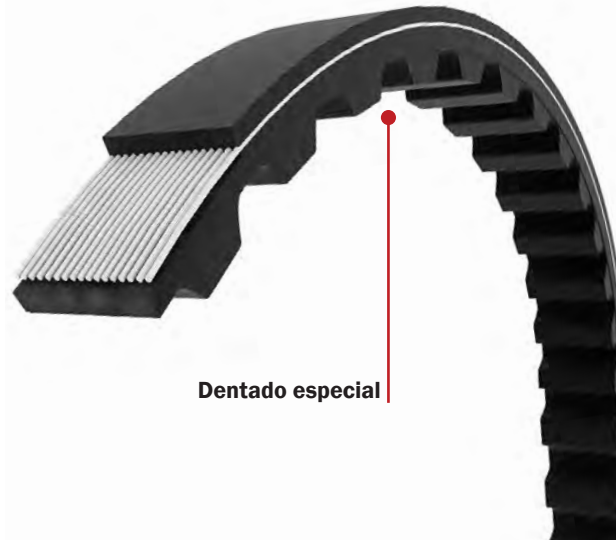

Dentado especial

Notas: HV en el número de parte denota construcción pesada, la cual tiene un espesor de 700+

Poleas recomendadas. Contacte a su Ingeniero de Servicio.

BANDAS VELOCIDAD VARIABLE

DESCRIPCIÓN	CÓDIGO	LONG. EXT. (PULG.)	ANCHO (PULG.)	ÁNGULO (°)	DESCRIPCIÓN	CÓDIGO	LONG. EXT. (PULG.)	ANCHO (PULG.)	ÁNGULO (°)
1228V255	98040729	26.1	3/4	28	1422V470	98040818	47.5	7/8	22
1230V341	98040814	34.6	3/4	30	1422V480	98040337	48.7	7/8	22
1230V348	98040815	35.3	3/4	30	1422V540	98040331	54.8	7/8	22
1330V242	98040447	24.7	13/16	22	1422V600	98040332	60.7	7/8	22
1422V235	98040816	24	7/8	22	1422V660	98040333	66.7	7/8	22
1422V240	98040495	24.7	7/8	22	1422V780	98040339	78.7	7/8	22
1422V270	98040494	27.7	7/8	22	1426V298	98040259	30.4	7/8	26
1422V290	98040584	29.6	7/8	22	1426V299	98040656	30.5	7/8	26
1422V300	98040493	30.7	7/8	22	1426V328	98040636	33.3	7/8	26
1422V330	98040492	33.7	7/8	22	1426V362	98040635	36.7	7/8	26
1422V340	98040708	34.6	7/8	22	1430V215	98040702	21.8	7/8	30
1422V360	98040328	36.7	7/8	22	1430V315	98040819	32	7/8	30
1422V400	98040348	40.8	7/8	22	1430V375	98040820	38	7/8	30
1422V420	98040329	42.8	7/8	22	1430V450	98040849	45.6	7/8	30
1422V440	98040817	44.5	7/8	22	1430V500	98040850	50.5	7/8	30
1422V460	98040768	46.5	7/8	22	1524V301	98040821	30.6	15/16	24
1422V466	98040325	47	7/8	22	1526V264	98040505	27	15/16	26

BANDAS VELOCIDAD VARIABLE

DESCRIPCIÓN	CÓDIGO	LONG. EXT. (PULG.)	ANCHO (PULG.)	ÁNGULO (°)	DESCRIPCIÓN	CÓDIGO	LONG. EXT. (PULG.)	ANCHO (PULG.)	ÁNGULO (°)
1526V294	98040506	30	15/16	26	1922V321	98040070	33	1 3/16	22
1528V298	98040769	30.3	15/16	28	1922V332	98040713	34	1 3/16	22
1528V326	98040770	33.1	15/16	28	1922V338	98040501	34.7	1 3/16	22
1528V360	98040771	36.5	15/16	28	1922V363	98040027	37.1	1 3/16	22
1528V414	98040772	41.9	15/16	28	1922V381	98040307	38.8	1 3/16	22
1622V270	98040822	27.5	1	22	1922V386	98040071	39.3	1 3/16	22
1622V297	98040823	30.2	1	22	1922V403	98040530	41.4	1 3/16	22
1622V307	98040571	31.1	1	22	1922V417	98040376	42.5	1 3/16	22
1622V336	98040824	34.1	1	22	1922V426	98040063	43.4	1 3/16	22
1622V520	98040572	52.5	1	22	1922V443	98040072	45.1	1 3/16	22
1626V262	98040773	26.7	1	26	1922V454	98040028	46.2	1 3/16	22
1626V290	98040536	29.8	1	26	1922V460	98040622	46.8	1 3/16	22
1626V293	98040588	30	1	26	1922V484	98040057	49.2	1 3/16	22
1626V304	98040305	31.1	1	26	1922V526	98040602	53.3	1 3/16	22
1626V330	98040293	33.8	1	26	1922V544	98040029	55.1	1 3/16	22
1626V339	98040248	34.7	1	26	1922V604	98040026	61.2	1 3/16	22
1626V380	98040774	38.5	1	26	1922V630	98040779	63.6	1 3/16	22
1626V384	98040308	39.2	1	26	1922V646	98040074	65.4	1 3/16	22
1626V395	98040618	40.3	1	26	1922V666	98040075	67.4	1 3/16	22
1626V411	98040537	41.9	1	26	1922V686	98040603	69.3	1 3/16	22
1626V428	98040775	43.3	1	26	1922V706	98040569	71.3	1 3/16	22
1626V440	98040291	44.7	1	26	1922V726	98040673	73	1 3/16	22
1626V455	98040617	46.2	1	26	1922V751	98040007	75.8	1 3/16	22
1626V513	98040776	51.8	1	26	1922V756	98040179	76.4	1 3/16	22
1626V517	98040249	52.1	1	26	1922V806	98040674	81.3	1 3/16	22
1626V597	98040393	60.6	1	26	1922V846	98040716	85.4	1 3/16	22
1626V604	98040306	61.2	1	26	1922V1006	98040676	101	1 3/16	22
1626V658	98040397	66.7	1	26	1922V1026	98040825	103	1 3/16	22
1626V700	98040403	70.8	1	26	1922V1146	98040719	115	1 3/16	22
1628V210	98040686	21.2	1	28	1926V249	98040621	25.3	1 3/16	26
1628V315	98040313	32.7	1	28	1926V250	98040633	25.7	1 3/16	26
1632V210	98040323	21.9	1	32	1926V275	98040688	28.1	1 3/16	26
1822V290	98040648	29.5	1 1/8	22	1926V333	98040255	33.9	1 3/16	26
1822V328	98040651	33.5	1 1/8	22	1926V367	98040050	37.2	1 3/16	26
1826V250	98040592	25.4	1 1/8	26	1926V376	98040624	38.8	1 3/16	26
1828V368	98040284	37.6	1 1/8	28	1926V380	98040509	38.9	1 3/16	26
1832V338	98040777	34.4	1 1/8	32	1926V390	98040780	39.6	1 3/16	26
1922V256	98040253	26.4	1 3/16	22	1926V407	98040256	41.4	1 3/16	26
1922V277	98040611	28.2	1 3/16	22	1926V415	98040826	42.1	1 3/16	26
1922V282	98040060	29	1 3/16	22	1926V427	98040827	40.3	1 3/16	26
1922V298	98040500	30.6	1 3/16	22	1926V507	98040508	51.4	1 3/16	26
1922V302	98040778	30.8	1 3/16	22	1926V542	98040638	55.4	1 3/16	26

BANDAS VELOCIDAD VARIABLE

DESCRIPCIÓN	CÓDIGO	LONG. EXT. (PULG.)	ANCHO (PULG.)	ÁNGULO (°)	DESCRIPCIÓN	CÓDIGO	LONG. EXT. (PULG.)	ANCHO (PULG.)	ÁNGULO (°)
1930V355	98040828	36.1	1 3/16	30	2126V377	98040843	38.4	1 5/16	30
1930V366	98040781	37.2	1 3/16	30	2126V468	98040721	47.7	1 5/16	30
1930V375	98040782	38.1	1 3/16	30	2130V374	98040749	38	1 5/16	30
1930V400	98040144	40.7	1 3/16	30	2226V307	98040677	31.2	1 3/8	26
1930V425	98040790	43.1	1 3/16	30	2230V266	98040615	27.5	1 3/8	30
1930V431	98040709	44	1 3/16	30	2230V273	98040786	27.9	1 3/8	30
1930V450	98040829	45.6	1 3/16	30	2230V275	98040358	28.1	1 3/8	30
1930V475	98040830	48.1	1 3/16	30	2230V326	98040725	33.5	1 3/8	30
1930V485	98040177	49.1	1 3/16	30	2230V375	98040678	38.2	1 3/8	30
1930V491	98040710	50	1 3/16	30	2322V329	98040679	33.4	1 7/16	22
1930V500	98040831	50.6	1 3/16	30	2322V347	98040680	35.2	1 7/16	22
1930V530	98040783	53.6	1 3/16	30	2322V364	98040058	37.2	1 7/16	22
1930V541	98040220	55	1 3/16	30	2322V384	98040905	39.3	1 7/16	22
1930V560	98040764	56.9	1 3/16	30	2322V396	98040547	40.6	1 7/16	22
1930V585	98040178	59.1	1 3/16	30	2322V421	98040076	42.9	1 7/16	22
1930V591	98040760	60	1 3/16	30	2322V434	98040681	44.2	1 7/16	22
1930V600	98040784	60.6	1 3/16	30	2322V441	98040127	45.1	1 7/16	22
1930V630	98040832	63.6	1 3/16	30	2322V461	98040726	47	1 7/16	22
1930V641	98040221	64.6	1 3/16	30	2322V481	98040053	49.2	1 7/16	22
1930V691	98040210	69.6	1 3/16	30	2322V521	98040044	52.8	1 7/16	22
1930V750	98040209	75.6	1 3/16	30	2322V541	98040059	55.1	1 7/16	22
1930V791	98040222	79.6	1 3/16	30	2322V601	98040025	61.2	1 7/16	22
1930V800	98040835	80.6	1 3/16	30	2322V621	98040734	63	1 7/16	22
1930V850	98040836	85.6	1 3/16	30	2322V661	98040078	67.4	1 7/16	22
1930V891	98040206	89.6	1 3/16	30	2322V681	98040073	68.8	1 7/16	22
1930V900	98040837	90.6	1 3/16	30	2322V701	98040162	71.4	1 7/16	22
1930V950	98040838	95.6	1 3/16	30	2322V721	98040062	73.4	1 7/16	22
1930V991	98040181	99.6	1 3/16	30	2322V801	98040079	81.4	1 7/16	22
1930V1000	98040892	101.2	1 3/16	30	2322V846	98040787	85.3	1 7/16	22
1930V1060	98040839	106.6	1 3/16	30	2322V886	98040714	89.5	1 7/16	22
1930V1091	98040223	109.6	1 3/16	30	2322V1001	98040080	101	1 7/16	22
1930V1120	98040840	112.6	1 3/16	30	2322V1061	98040788	107	1 7/16	22
1930V1191	98040373	119.6	1 3/16	30	2326V310	98040706	31.8	1 7/16	26
2026V422	98040394	43	1 1/4	26	2326V359	98040789	36.6	1 7/16	26
2026V445	98040520	45.2	1 1/4	26	2330V273	98040619	27.9	1 7/16	30
2026V474	98040574	48.2	1 1/4	26	2330V338	98000728	34.6	1 7/16	30
2026V607	98040395	61.5	1 1/4	26	2330V359	98040690	36.5	1 7/16	30
2030V381	98040640	38.5	1 1/4	30	2330V537	98040682	54.6	1 7/16	30
2126V297	98040842	30.4	1 5/16	26	2332V373	98040479	38	1 7/16	32
2126V307	98040785	31.4	1 5/16	26	2422V570	98040844	57.7	1 1/2	22
2126V309	98040314	31.7	1 5/16	30	2426V343	98000483	35.4	1 1/2	26
2126V365	98040526	37.4	1 5/16	30	2428V757	98040054	76.6	1 1/2	28

BANDAS VELOCIDAD VARIABLE

DESCRIPCIÓN	CÓDIGO	LONG. EXT. (PULG.)	ANCHO (PULG.)	ÁNGULO (°)	DESCRIPCIÓN	CÓDIGO	LONG. EXT. (PULG.)	ANCHO (PULG.)	ÁNGULO (°)
2430V297	98040717	30.7	1 1/2	30	2626V369	98000645	37.4	1 5/8	26
2430V302	98040845	30.9	1 1/2	30	2626V388	98000649	39.7	1 5/8	26
2430V319	98040846	32.6	1 1/2	30	2630V345	98000616	35.3	1 5/8	30
2430V345	98040847	35.2	1 1/2	30	2630V395	98040858	40.2	1 5/8	30
2430V379	98040848	38.6	1 1/2	30	2636V332	98000360	34	1 5/8	36
2436V331	98040366	34	1 1/2	36	2822V778	98000017	79.5	1 3/4	22
2526V302	98000069	30.7	1 9/16	26	2826V412	98000646	41.9	1 3/4	26
2526V314	98000002	32.4	1 9/16	26	2826V452	98000650	46	1 3/4	26
2528V370	98040851	37.7	1 9/16	28	2830V337	98000691	34.8	1 3/4	30
2530V300	98000521	31	1 9/16	30	2830V363	98330662	36.8	1 3/4	30
2530V335	98040852	34.2	1 9/16	30	2830V366	98330434	37.2	1 3/4	30
2530V470	98040791	47.7	1 9/16	30	2830V367	98000916	37.9	1 3/4	30
2530V490	98000326	50	1 9/16	30	2830V393	98000664	39.9	1 3/4	30
2530V500	98000712	50.9	1 9/16	30	2830V396	98330435	40.3	1 3/4	30
2530V530	98000654	54	1 9/16	30	2830V422	98000665	42.7	1 3/4	30
2530V550	98000436	56	1 9/16	30	2830V428	98040859	43.6	1 3/4	30
2530V560	98040853	56.7	1 9/16	30	2830V492	98040860	50.1	1 3/4	30
2530V575	98330730	58.5	1 9/16	30	2836V343	98000120	35.1	1 3/4	36
2530V595	98000166	60.7	1 9/16	30	2836V350	98000324	35.8	1 3/4	36
2530V600	98040793	60.7	1 9/16	30	2836V380	98000367	38.8	1 3/4	36
2530V610	98000437	62	1 9/16	30	2926V366	98040081	37.5	1 13/16	26
2530V618	98000260	62.5	1 9/16	30	2926V400	98040759	40.8	1 13/16	26
2530V630	98000164	64.2	1 9/16	30	2926V426	98000258	43.5	1 13/16	26
2530V660	98000438	67	1 9/16	30	2926V471	98000082	48	1 13/16	26
2530V670	98000165	68.2	1 9/16	30	2926V477	98040762	48.5	1 13/16	26
2530V680	98040854	68.7	1 9/16	30	2926V486	98000083	49.2	1 13/16	26
2530V690	98000439	70	1 9/16	30	2926V491	98000084	50	1 13/16	26
2530V700	98000275	71	1 9/16	30	2926V521	98000064	53	1 13/16	26
2530V730	98000211	74.2	1 9/16	30	2926V534	98040861	54.2	1 13/16	26
2530V740	98000683	75	1 9/16	30	2926V546	98000067	55.5	1 13/16	26
2530V750	98000180	76.2	1 9/16	30	2926V574	98000085	58.3	1 13/16	26
2530V790	98000214	80	1 9/16	30	2926V586	98000068	59.5	1 13/16	26
2530V840	98000215	85	1 9/16	30	2926V606	98000015	61.5	1 13/16	26
2530V850	98040857	85.7	1 9/16	30	2926V616	98000149	63.3	1 13/16	26
2530V890	98000216	90	1 9/16	30	2926V636	98000086	64.4	1 13/16	26
2530V934	98000163	94.4	1 9/16	30	2926V646	98000087	65.5	1 13/16	26
2530V990	98000217	100	1 9/16	30	2926V666	98000088	67.5	1 13/16	26
2530V1090	98000218	110	1 9/16	30	2926V686	98000089	69.5	1 13/16	26
2530V1190	98000219	120	1 9/16	30	2926V706	98000118	71.5	1 13/16	26
2530V1290	98000207	130	1 9/16	30	2926V726	98000035	73.5	1 13/16	26
2530V1490	98000904	150	1 9/16	30	2926V776	98000090	78.5	1 13/16	26
2530V1690	98000794	170	1 9/16	30	2926V786	98000735	79.4	1 13/16	26

BANDAS VELOCIDAD VARIABLE

DESCRIPCIÓN	CÓDIGO	LONG. EXT. (PULG.)	ANCHO (PULG.)	ÁNGULO (°)	DESCRIPCIÓN	CÓDIGO	LONG. EXT. (PULG.)	ANCHO (PULG.)	ÁNGULO (°)
2926V834	98000704	84.2	1 13/16	26	3230V850	98040873	85.8	2	30
2926V856	98000040	86.4	1 13/16	26	3230V1180	98040875	119	2	30
2926V891	98040092	90	1 13/16	26	3230HV856	98000756	86.7	2	30
2926V906	98000093	91.5	1 13/16	26	3230HV931	98000755	94.2	2	30
2926V966	98000094	97.5	1 13/16	26	3236V369	98000122	37.7	2	36
2926V1006	98000095	101.5	1 13/16	26	3236V389	98000121	39.7	2	36
2926V1026	98000684	103.6	1 13/16	26	3236V432	98000368	44.2	2	36
2926V1086	98000685	109.6	1 13/16	26	3236HV528	98000612	53.8	2	36
2930V348	98330727	35.5	1 13/16	30	3236HV553	98000604	56.3	2	36
2930V492	98000590	50	1 13/16	30	3236HV570	98000605	58	2	36
3028V386	98000529	39.4	1 7/8	28	3236HV585	98000606	59.5	2	36
3030V357	98000692	36.5	1 7/8	30	3236HV603	98000607	61.3	2	36
3030V377	98040863	38.7	1 7/8	30	3236HV613	98000347	62.2	2	36
3030V387	98000694	39.6	1 7/8	30	3236HV620	98000608	63	2	36
3036V351	98000310	36	1 7/8	36	3236HV626	98000370	63.6	2	36
3226V392	98000670	39.8	2	26	3236HV644	98000371	65.4	2	36
3226V400	98000012	41.1	2	26	3236HV670	98000372	68	2	36
3226V433	98040581	44.1	2	26	3236HV702	98000048	71.1	2	36
3226V439	98040864	44.7	2	26	3236HV723	98000431	73.2	2	36
3226V450	98000695	45.8	2	26	3236HV821	98000639	83.1	2	36
3226V465	98000400	47.4	2	26	3326V478	98000628	48.5	2 1/16	26
3226V505	98000543	51.4	2	26	3428V451	98040876	46	2 1/8	28
3226V514	98000647	52.3	2	26	3430V424	98040877	43.3	2 1/8	30
3226V545	98000477	55.3	2	26	3430V476	98000878	48.8	2 1/8	30
3226V585	98000542	59.4	2	26	3430V493	98040879	50.1	2 1/8	30
3226V603	98000701	61.4	2	26	3432V450	98040880	45.8	2 1/8	32
3226V650	98040763	65.9	2	26	3432V456	98040797	46.5	2 1/8	32
3226V663	98000423	67.4	2	26	3432V480	98040881	48.8	2 1/8	32
3226V690	98040865	69.8	2	26	3432V484	98040798	49.3	2 1/8	32
3226V723	98000424	73.4	2	26	3432V528	98040882	53.4	2 1/8	32
3226V783	98000700	79.5	2	26	3432V534	98040799	54.3	2 1/8	32
3226V843	98000426	85.4	2	26	3436V404	98040364	41.3	2 1/8	36
3226V903	98000427	91.4	2	26	3626V556	98000671	56.5	2 1/4	26
3226V963	98000428	97.4	2	26	3630V455	98040883	46.4	2 1/4	30
3226V1023	98000429	103	2	26	3636V479	98000361	48.8	2 1/4	36
3226V1083	98000430	109	2	26	3726V558	98000757	56.9	2 5/16	26
3230V419	98000653	42.7	2	30	3826V459	98040004	46.8	2 3/8	26
3230V481	98040866	48.9	2	30	3826V465	98000055	47.5	2 3/8	26
3230V560	98040795	56.8	2	30	3830V501	98000379	51	2 3/8	30
3230V630	98040868	63.8	2	30	3830V510	98000689	52	2 3/8	30
3230V670	98040796	67.8	2	30	3830V517	98000614	52.7	2 3/8	30
3230V701	98040869	70.9	2	30	3830V580	98000696	59	2 3/8	30

BANDAS VELOCIDAD VARIABLE

DESCRIPCIÓN	CÓDIGO	LONG. EXT. (PULG.)	ANCHO (PULG.)	ÁNGULO (°)	DESCRIPCIÓN	CÓDIGO	LONG. EXT. (PULG.)	ANCHO (PULG.)	ÁNGULO (°)
3830V587	98040800	59.6	2 3/8	30	4430V1090	98000153	110	2 3/4	30
3836V418	98000124	42.7	2 3/8	36	4430V1150	98000658	116	2 3/8	30
3836V426	98000123	43.6	2 3/8	36	4430V1250	98000752	126.1	2 3/4	30
3836V654	98040801	66.3	2 3/8	36	4430V1320	98000171	133	2 3/4	30
4030V538	98040687	54.5	2 1/2	30	4430V1410	98000765	142	2 3/4	30
4030V590	98040884	60	2 1/2	30	4430V1460	98000766	147	2 3/4	30
4036V541	98000562	55.4	2 1/2	36	4430V1610	98000767	162	2 3/4	30
4036V574	98000369	58.3	2 1/2	36	4430V1810	98000808	182	2 3/4	30
4230V503	98000637	51.4	2 5/8	30	4430V1917	98000809	192.7	2 3/4	30
4230V556	98000601	56.8	2 5/8	30	4436V525	98000125	53.5	2 3/4	36
4230V605	98000489	61	2 5/8	30	4436V551	98000154	56.1	2 3/4	36
4234V998	98000143	100.9	2 5/8	34	4436V555	98000066	56.5	2 3/4	36
4330V521	98000594	53.2	2 11/16	30	4436V561	98040810	57.1	2 3/4	36
4430V510	98000513	52	2 3/4	30	4436V576	98000131	58.6	2 3/4	36
4430V530	98000736	54	2 3/4	30	4436V581	98040811	59.1	2 3/4	36
4430V548	98000463	55	2 3/4	30	4436V646	98000522	65.5	2 3/4	36
4430V555	98000132	56.5	2 3/4	30	4436V714	98000363	72.7	2 3/4	36
4430V560	98040886	57	2 3/4	30	4626V596	98000011	60.6	2 7/8	26
4430V570	98040887	58	2 3/4	30	4630V650	98000613	66.1	2 7/8	30
4430V578	98000441	59	2 3/4	30	4630V663	98000378	67.3	2 7/8	30
4430V600	98040803	61	2 3/4	30	4630V668	98000698	68.1	2 7/8	30
4430V610	98000111	62	2 3/4	30	4630V683	98000464	69.3	2 7/8	30
4430V630	98000442	64	2 3/4	30	4630V733	98000699	74.3	2 7/8	30
4430V652	98040888	66.2	2 3/4	30	4630V1070	98000034	108.1	2 7/8	30
4430V660	98000443	67	2 3/4	30	4632V722	98000510	73.5	2 7/8	32
4430V670	98000112	68	2 3/4	30	4636V613	98000362	62.2	2 7/8	36
4430V690	98000444	70	2 3/4	30	4830V602	98000652	61.1	3	30
4430V700	98000150	71	2 3/4	30	4830V614	98000548	62.5	3	30
4430V710	98040889	72.1	2 3/4	30	4830V653	98000546	66.4	3	30
4430V718	98040804	72.8	2 3/4	30	4830V692	98000545	70.3	3	30
4430V730	98000065	74	2 3/4	30	4830V699	98000610	71	3	30
4430V740	98000445	75	2 3/4	30	4830V730	98000544	74.1	3	30
4430V750	98040805	76	2 3/4	30	4830V750	98000813	76	3	30
4430V760	98040806	77	2 3/4	30	4830V850	98000566	86.1	3	30
4430V772	98330723	78.6	2 3/4	30	4830V970	98000567	98.1	3	30
4430V780	98040890	79	2 3/4	30	4830V1070	98000598	108	3	30
4430V790	98000113	80	2 3/4	30	4836V588	98000010	59.8	3	36
4430V850	98000114	86	2 3/4	30	4836V608	98000096	61.9	3	36
4430V910	98000115	92	2 3/4	30	4836V618	98000155	63.4	3	36
4430V970	98000116	98	2 3/4	30	4836V642	98000609	65.3	3	36
4430V1000	98000753	101.1	2 3/4	30	4836V655	98000133	66.6	3	36
4430V1030	98000117	104	2 3/4	30	4836V729	98000101	74	3	36

BANDAS VELOCIDAD VARIABLE

DESCRIPCIÓN	CÓDIGO	LONG. EXT. (PULG.)	ANCHO (PULG.)	ÁNGULO (°)
4836V789	98000102	80	3	36
4836V850	98000031	86.1	3	36
4836V1180	98000758	119	3	36
5126V938	98000246	95	3 3/16	26
5130V732	98000663	74.6	3 3/16	30
5228V930	98000894	94.4	3 1/4	28
5228V930S	98000737	94.4	3 1/4	28
5230V662	98000660	67.3	3 1/4	30
5230V734	98000893	75.3	3 1/4	30
5230V734S	98000657	75.3	3 1/4	30
5230V867	98000895	88.3	3 1/4	30
5230V867S	98000659	88.3	3 1/4	30
5636V750	98000235	76.4	3 1/2	36
5636V774	98000237	78.7	3 1/2	36
5830V756	98000661	76.9	3 5/8	30
5836V737	98000309	75	3 5/8	36
6036V761	98330738	77.7	3 3/4	36
6036V850	98000105	86.3	3 3/4	36
6236V694	98000147	70.8	3 7/8	36
6236V725	98040006	73.9	3 7/8	36
6236V762	98000104	77.6	3 7/8	36
6236V785	98040009	79.9	3 7/8	36
46236V905	98000013	91.9	3 7/8	36

BANDAS TRUFLEX® V

Las bandas Truflex® se caracterizan por su desempeño superior y estabilidad en aplicaciones de servicio moderado y ligero.

MERCADOS/APLICACIONES

Conveniente para todas las aplicaciones industriales ligeras, usualmente en motores con potencia de fracción de caballos (FHP).

CARACTERÍSTICAS/VENTAJAS

- Las Curvas de Gates® proporcionan un mayor soporte y máximo contacto con la ranura de la polea para carga uniforme y amplia vida útil.
- Las Cuerdas Flex-Bonded® están fuertemente unidas al cuerpo de la banda, resultando en una distribución uniforme de la carga, que resulta en la absorción de esfuerzos aún en poleas de diámetro pequeño.
- La Cubierta Flex-Weave® es una construcción patentada que ofrece larga vida de la cubierta, proporcionando protección adicional al cuerpo de la banda, protegiéndola de la reacción con derivados de petróleo, polvo y calor.
- Satisface los estándares RMA de resistencia al petróleo y calor.
- Satisface los requerimientos RMA de conductividad estática.

Poleas recomendadas: Poleas Light Duty Barrenada a tamaño. Poleas Light Duty Pulgada variable. Poleas Light Duty Buje.

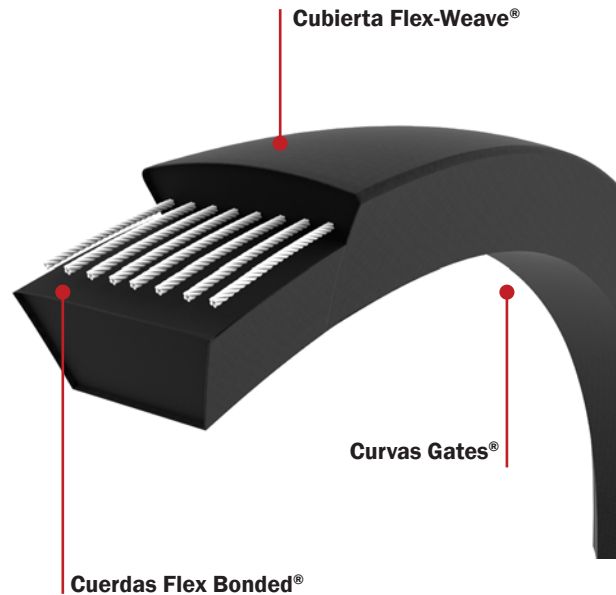

Notas: Las bandas Truflex® están disponibles en secciones 2L (0), 3L (1), 4L (2), 5L (3)

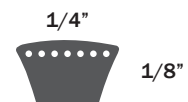

BANDA TRUFLEX® V

SECCIÓN 0 Ó 2L

DESCRIPCIÓN	PRODUCTO	CÓDIGO	PESO (LBS.)
0100	2L100	84000100	0.01
0110	2L110	84000110	0.01
0120	2L120	84000120	0.02
0130	2L130	84000130	0.02
0140	2L140	84000140	0.02
0150	2L150	84000150	0.02
0160	2L160	84000160	0.02
0170	2L170	84000170	0.02
0180	2L180	84000180	0.02

DESCRIPCIÓN	PRODUCTO	CÓDIGO	PESO (LBS.)
0190	2L190	84000190	0.02
0200	2L200	84000200	0.03
0210	2L210	84000210	0.03
0230	2L230	84000230	0.03
0240	2L240	84000240	0.03
0250	2L250	84000250	0.02
0260	2L260	84000260	0.04

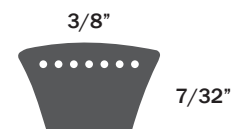

BANDA TRUFLEX® V

SECCIÓN 1 Ó 3L

DESCRIPCIÓN	PRODUCTO	CÓDIGO	PESO (LBS.)
0270	2L270	84000270	0.04
0280	2L280	84000280	0.04
0290	2L290	84000290	0.04
0310	2L310	84000310	0.04
0340	2L340	84000340	0.05
0350	2L350	84000350	0.05
0360	2L360	84000360	0.05
0380	2L380	84000380	0.05
0460	2L460	84000460	0.07
1110	3L110	84001110	0.05
1120	3L120	84001120	0.06
1130	3L130	84001130	0.06
1140	3L140	84001140	0.06
1150	3L150	84001150	0.06
1160	3L160	84001160	0.07
1170	3L170	84001170	0.07
1180	3L180	84001180	0.07
1190	3L190	84001190	0.07
1200	3L200	84001200	0.08
1210	3L210	84001210	0.07
1110	3L110	84001110	0.05
1120	3L120	84001120	0.06
1130	3L130	84001130	0.06
1140	3L140	84001140	0.06
1150	3L150	84001150	0.06
1160	3L160	84001160	0.07
1170	3L170	84001170	0.07
1180	3L180	84001180	0.07
1190	3L190	84001190	0.07
1200	3L200	84001200	0.08
1210	3L210	84001210	0.07
1220	3L220	84031220	0.08
1230	3L230	84031230	0.08
1240	3L240	84031240	0.08
1250	3L250	84031250	0.08
1255	3L255	84031255	0.09
1260	3L260	84031260	0.09
1270	3L270	84031270	0.09
1280	3L280	84031280	0.10

DESCRIPCIÓN	PRODUCTO	CÓDIGO	PESO (LBS.)
1290	3L290	84031290	0.10
1300	3L300	84031300	0.11
1310	3L310	84031310	0.11
1320	3L320	84031320	0.11
1330	3L330	84031330	0.11
1340	3L340	84031340	0.11
1350	3L350	84031350	0.12
1360	3L360	84031360	0.12
1370	3L370	84031370	0.12
1380	3L380	84031380	0.13
1390	3L390	84031390	0.13
1400	3L400	84031400	0.14
1410	3L410	84031410	0.14
1420	3L420	84031420	0.14
1430	3L430	84031430	0.16
1440	3L440	84031440	0.16
1450	3L450	84031450	0.17
1460	3L460	84031460	0.17
1470	3L470	84031470	0.17
1480	3L480	84031480	0.17
1490	3L490	84031490	0.17
1500	3L500	84031500	0.18
1510	3L510	84031510	0.18
1520	3L520	84031520	0.18
1530	3L530	84031530	0.19
1540	3L540	84031540	0.19
1550	3L550	84031550	0.20
1560	3L560	84031560	0.20
1570	3L570	84031570	0.20
1580	3L580	84031580	0.20
1590	3L590	84031590	0.20
1600	3L600	84031600	0.21
1610	3L610	84031610	0.21
1620	3L620	84031620	0.21
1630	3L630	84031630	0.22
1640	3L640	84031640	0.22
1650	3L650	84031650	0.23
1670	3L670	84031670	0.23
1680	3L680	84031680	0.23

BANDAS TRUFLEX® V

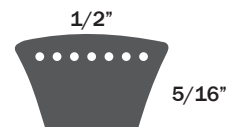
**BANDA TRUFLEX® V****SECCIÓN 2 Ó 4L**

DESCRIPCIÓN	PRODUCTO	CÓDIGO	PESO (LBS.)
2160	4L160	84032160	0.09
2170	4L170	84032170	0.09
2180	4L180	84032180	0.10
2190	4L190	84032190	0.10
2200	4L200	84032200	0.10
2210	4L210	84032210	0.11
2220	4L220	84032220	0.11
2230	4L230	84032230	0.12
2240	4L240	84032240	0.12
2250	4L250	84032250	0.12
2260	4L260	84032260	0.14
2270	4L270	84032270	0.14
2280	4L280	84032280	0.15
2290	4L290	84032290	0.15
2300	4L300	84032300	0.15
2310	4L310	84032310	0.17
2320	4L320	84032320	0.17
2330	4L330	84032330	0.18
2340	4L340	84032340	0.18
2350	4L350	84032350	0.18
2360	4L360	84032360	0.20
2370	4L370	84032370	0.20
2380	4L380	84032380	0.21
2390	4L390	84032390	0.21
2400	4L400	84032400	0.21
2410	4L410	84032410	0.23
2420	4L420	84032420	0.23
2430	4L430	84032430	0.24

DESCRIPCIÓN	PRODUCTO	CÓDIGO	PESO (LBS.)
2440	4L440	84032440	0.24
2450	4L450	84032450	0.24
2460	4L460	84032460	0.24
2470	4L470	84032470	0.25
2480	4L480	84032480	0.26
2490	4L490	84032490	0.27
2500	4L500	84032500	0.27
2510	4L510	84032510	0.28
2520	4L520	84032520	0.29
2530	4L530	84032530	0.29
2540	4L540	84032540	0.30
2550	4L550	84032550	0.30
2560	4L560	84032560	0.30
2570	4L570	84032570	0.30
2580	4L580	84032580	0.30
2590	4L590	84032590	0.30
2600	4L600	84032600	0.30
2610	4L610	84032610	0.30
2620	4L620	84032620	0.30
2630	4L630	84032630	0.30
2640	4L640	84032640	0.40
2650	4L650	84032650	0.40
2660	4L660	84032660	0.40
2670	4L670	84032670	0.40
2680	4L680	84032680	0.40
2690	4L690	84032690	0.40
2700	4L700	84032700	0.40
2750	4L750	84032750	0.40

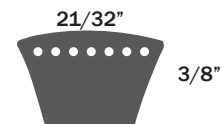
**BANDA TRUFLEX® V****SECCIÓN 3 Ó 5L**

DESCRIPCIÓN	PRODUCTO	CÓDIGO	PESO (LBS.)
3230	5L230	84003230	0.20
3240	5L240	84003240	0.22
3250	5L250	84003250	0.22
3260	5L260	84003260	0.23

DESCRIPCIÓN	PRODUCTO	CÓDIGO	PESO (LBS.)
3265	5L265	84003265	0.23
3270	5L270	84003270	0.24
3280	5L280	84003280	0.25
3290	5L290	84003290	0.25

BANDA TRUFLEX® V**SECCIÓN 3 Ó 5L**

DESCRIPCIÓN	PRODUCTO	CÓDIGO	PESO (LBS.)
3300	5L300	84003300	0.26
3310	5L310	84003310	0.27
3320	5L320	84003320	0.28
3330	5L330	84003330	0.29
3340	5L340	84003340	0.30
3350	5L350	84003350	0.30
3370	5L370	84003370	0.32
3380	5L380	84003380	0.33
3390	5L390	84003390	0.34
3400	5L400	84003400	0.35
3410	5L410	84003410	0.35
3420	5L420	84003420	0.36
3430	5L430	84003430	0.37
3440	5L440	84003440	0.38
3450	5L450	84003450	0.39
3460	5L460	84003460	0.40
3470	5L470	84003470	0.40
3480	5L480	84003480	0.41
3490	5L490	84003490	0.42
3500	5L500	84003500	0.43
3510	5L510	84003510	0.44

DESCRIPCIÓN	PRODUCTO	CÓDIGO	PESO (LBS.)
3520	5L520	84003520	0.45
3530	5L530	84003530	0.45
3540	5L540	84003540	0.46
3550	5L550	84003550	0.47
3560	5L560	84003560	0.48
3570	5L570	84003570	0.49
3580	5L580	84003580	0.49
3590	5L590	84003590	0.50
3600	5L600	84003600	0.51
3610	5L610	84003610	0.52
3620	5L620	84003620	0.53
3630	5L630	84003630	0.54
3640	5L640	84003640	0.55
3650	5L650	84003650	0.55
3660	5L660	84003660	0.56
3670	5L670	84003670	0.57
3680	5L680	84003680	0.58
3690	5L690	84003690	0.59
3700	5L700	84003700	0.60
3710	5L710	84003710	0.60

SECCIÓN 3 Ó 5L

DESCRIPCIÓN	PRODUCTO	CÓDIGO	PESO (LBS.)	DESCRIPCIÓN	PRODUCTO	CÓDIGO	PESO (LBS.)	DESCRIPCIÓN	PRODUCTO	CÓDIGO	PESO (LBS.)
3230	5L230	84003230	0.2	3380	5L380	84003380	0.33	3550	5L550	84003550	0.47
3240	5L240	84003240	0.22	3390	5L390	84003390	0.34	3560	5L560	84003560	0.48
3250	5L250	84003250	0.22	3400	5L400	84003400	0.35	3570	5L570	84003570	0.49
3260	5L260	84003260	0.23	3410	5L410	84003410	0.35	3580	5L580	84003580	0.49
3265	5L265	84003265	0.23	3420	5L420	84003420	0.36	3590	5L590	84003590	0.5
3270	5L270	84003270	0.24	3430	5L430	84003430	0.37	3600	5L600	84003600	0.51
3280	5L280	84003280	0.25	3440	5L440	84003440	0.38	3610	5L610	84003610	0.52
3290	5L290	84003290	0.25	3450	5L450	84003450	0.39	3620	5L620	84003620	0.53
3300	5L300	84003300	0.26	3460	5L460	84003460	0.4	3630	5L630	84003630	0.54
3310	5L310	84003310	0.27	3470	5L470	84003470	0.4	3640	5L640	84003640	0.55
3320	5L320	84003320	0.28	3480	5L480	84003480	0.41	3650	5L650	84003650	0.55
3330	5L330	84003330	0.29	3490	5L490	84003490	0.42	3660	5L660	84003660	0.56
3340	5L340	84003340	0.3	3500	5L500	84003500	0.43	3670	5L670	84003670	0.57

SECCIÓN 3 Ó 5L

DESCRIPCIÓN	PRODUCTO	CÓDIGO	PESO (LBS.)	DESCRIPCIÓN	PRODUCTO	CÓDIGO	PESO (LBS.)	DESCRIPCIÓN	PRODUCTO	CÓDIGO	PESO (LBS.)
3350	5L350	84003350	0.3	3510	5L510	84003510	0.44	3680	5L680	84003680	0.58
3355	5L355	84003355	0.3	3520	5L520	84003520	0.45	3690	5L690	84003690	0.59
3360	5L360	84003360	0.31	3530	5L530	84003530	0.45	3700	5L700	84003700	0.6
3370	5L370	84003370	0.32	3540	5L540	84003540	0.46	3710	5L710	84003710	0.6
3770	5L770	84003770	0.65	3720	5L720	84003720	0.61	3820	5L820	84003820	0.69
3780	5L780	84003780	0.66	3730	5L730	84003730	0.62	3830	5L830	84003830	0.7
3790	5L790	84003790	0.67	3740	5L740	84003740	0.62	3840	5L840	84003840	0.71
3800	5L800	84003800	0.67	3750	5L750	84003750	0.63				
3810	5L810	84003810	0.68	3760	5L760	84003760	0.64				

BANDAS POLYFLEX®

Única con ángulo de 60° en su construcción, con poliuretano, es capaz de transmitir cargas elevadas a velocidades muy altas en menor espacio que las bandas en V.

MERCADOS/APLICACIONES

Entre muchas otras, algunas aplicaciones son en máquinas herramientas, periféricos computacionales, equipo médico, pequeños instrumentos, sopladores de transmisiones y máquinas de carpintería.

CARACTERÍSTICAS/VENTAJAS

- Poliuretano de alto módulo que proporciona resistencia a la fatiga, uso rudo, ozono y otras condiciones ambientales.
- Su proceso de fabricación la hace única pues se realiza en una sola colada, lo que permite baja vibración durante su operación.
- Su dorso dentado proporciona excelente estabilidad lateral y suaviza el esfuerzo al circular por poleas de diámetros pequeños.
- Trabaja en rangos de temperatura: -54°C a +85°C (-65°F a 180°F)



Poleas Recomendadas: Poleas Polyflex®.

Notas: Las bandas Polyflex® están disponibles en 3M, 5M, 7M y 11M secciones cruzadas. Para bandas igualadas se puede requerir un tiempo de entrega; para detalles contacte a Servicio a Clientes.

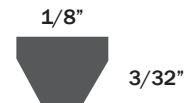

BANDA POLYFLEX®

3M

PRODUCTO	CÓDIGO	PESO (LBS.)	PRODUCTO	CÓDIGO	PESO (LBS.)	PRODUCTO	CÓDIGO	PESO (LBS.)	PRODUCTO	CÓDIGO	PESO (LBS.)
3M180	89010180	7.09	3M258	89010258	10.2	3M387	89010387	15.24	3M560	89010560	22.05
3M185	89010185	7.28	3M265	89010265	10.4	3M400	89010400	15.75	3M580	89010580	22.83
3M190	89010190	7.48	3M280	89010280	11	3M412	89010412	16.22	3M600	89010600	23.62
3M195	89010195	7.68	3M290	89010290	11.4	3M425	89010425	16.73	3M615	89010615	24.21
3M200	89010200	7.87	3M300	89010300	11.8	3M437	89010437	17.2	3M630	89010630	24.8
3M206	89010206	8.11	3M307	89010307	12.1	3M450	89010450	17.72	3M650	89010650	25.59
3M212	89010212	8.35	3M315	89010315	12.4	3M462	89010462	18.19	3M670	89010670	26.38
3M218	89010218	8.58	3M325	89010325	12.8	3M475	89010475	18.7	3M690	89010690	27.17
3M224	89010224	8.82	3M335	89010335	13.2	3M487	89010487	19.17	3M710	89010710	27.95
3M230	89010230	9.06	3M345	89010345	13.6	3M500	89010500	19.69	3M730	89010730	28.74
3M236	89010236	9.29	3M355	89010355	14	3M515	89010515	20.28	3M750	89010750	29.53
3M243	89010243	9.57	3M365	89010365	14.4	3M530	89010530	20.87			
3M250	89010250	9.84	3M375	89010375	14.76	3M545	89010545	21.46			

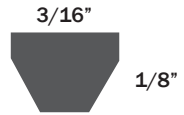

BANDA POLYFLEX®

5M

PRODUCTO	CÓDIGO	PESO (LBS.)	PRODUCTO	CÓDIGO	PESO (LBS.)	PRODUCTO	CÓDIGO	PESO (LBS.)	PRODUCTO	CÓDIGO	PESO (LBS.)
5M280	89020280	11.02	5M450	89020450	17.72	5M710	89020710	27.95	5M1120	89021120	44.09
5M290	89020290	11.42	5M462	89020462	18.19	5M730	89020730	28.74	5M1150	89021150	45.28
5M300	89020300	11.81	5M475	89020475	18.7	5M750	89020750	29.53	5M1180	89021180	46.46
5M307	89020307	12.09	5M487	89020487	19.17	5M775	89020775	30.51	5M1220	89021220	48.03
5M315	89020315	12.4	5M500	89020500	19.69	5M800	89020800	31.5	5M1250	89021250	49.21
5M325	89020325	12.8	5M515	89020515	20.28	5M825	89020825	32.48	5M1280	89021280	50.39
5M335	89020335	13.19	5M530	89020530	20.87	5M850	89020850	33.46	5M1320	89021320	51.97
5M345	89020345	13.58	5M545	89020545	21.46	5M875	89020875	34.45	5M1360	89021360	53.54
5M355	89020355	13.98	5M560	89020560	22.05	5M900	89020900	35.43	5M1400	89021400	55.12
5M365	89020365	14.37	5M580	89020580	22.83	5M925	89020925	36.42	5M1450	89021450	57.09
5M375	89020375	14.76	5M600	89020600	23.62	5M950	89020950	37.4	5M1500	89021500	59.06
5M387	89020387	15.24	5M615	89020615	24.21	5M975	89020975	38.39	5M1600	89021600	62.99
5M400	89020400	15.75	5M630	89020630	24.8	5M1000	89021000	39.37	5M1650	89021650	64.96
5M412	89020412	16.22	5M650	89020650	25.59	5M1030	89021030	40.55	5M1850	89021850	72.83
5M425	89020425	16.73	5M670	89020670	26.38	5M1060	89021060	41.73			
5M437	89020437	17.2	5M690	89020690	27.17	5M1090	89021090	42.91			

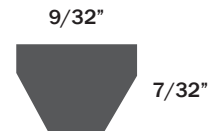

BANDA POLYFLEX®

7M

PRODUCTO	CÓDIGO	PESO (LBS.)	PRODUCTO	CÓDIGO	PESO (LBS.)	PRODUCTO	CÓDIGO	PESO (LBS.)	PRODUCTO	CÓDIGO	PESO (LBS.)
7M410	89030410	16.14	7M730	89030730	28.74	7M1120	89031120	44.09	7M1700	89031700	67
7M500	89030500	19.69	7M750	89030750	29.53	7M1150	89031150	45.28	7M1750	89031750	69
7M515	89030515	20.28	7M775	89030775	30.51	7M1180	89031180	46.46	7M1800	89031800	71
7M530	89030530	20.87	7M800	89030800	31.5	7M1220	89031220	48.03	7M1850	89031850	73
7M545	89030545	21.46	7M825	89030825	32.48	7M1250	89031250	49.21	7M1900	89031900	75
7M560	89030560	22.05	7M850	89030850	33.46	7M1280	89031280	50.39	7M1950	89031950	77
7M580	89030580	22.83	7M875	89030875	34.45	7M1320	89031320	51.97	7M2000	89032000	79
7M600	89030600	23.62	7M900	89030900	35.43	7M1360	89031360	53.54	7M2060	89032060	81
7M615	89030615	24.21	7M925	89030925	36.42	7M1400	89031400	55	7M2120	89032120	83
7M630	89030630	24.8	7M950	89030950	37.4	7M1450	89031450	57	7M2180	89032180	86
7M650	89030650	25.59	7M975	89030975	38.39	7M1500	89031500	59	7M2240	89032240	88
7M670	89030670	26.38	7M1000	89031000	39.37	7M1550	89031550	61	7M2300	89032300	91
7M690	89030690	27.17	7M1030	89031030	40.55	7M1600	89031600	63			
7M710	89030710	27.95	7M1090	89031090	42.91	7M1650	89031650	65			

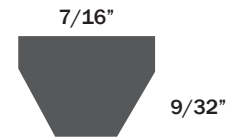

BANDA POLYFLEX®

11M

PRODUCTO	CÓDIGO	PESO (LBS.)	PRODUCTO	CÓDIGO	PESO (LBS.)	PRODUCTO	CÓDIGO	PESO (LBS.)	PRODUCTO	CÓDIGO	PESO (LBS.)
11M710	89040710	27.95	11M975	89040975	38.39	11M1320	89041320	51.97	11M1850	89041850	72.83
11M730	89040730	28.74	11M1000	89041000	39.37	11M1360	89041360	53.54	11M1900	89041900	74.8
11M750	89040750	29.53	11M1030	89041030	40.55	11M1400	89041400	55.12	11M1950	89041950	76.77
11M775	89040775	30.51	11M1060	89041060	41.73	11M1450	89041450	57.09	11M2000	89042000	78.74
11M800	89040800	31.5	11M1090	89041090	42.91	11M1500	89041500	59.06	11M2060	89042060	81.1
11M825	89040825	32.48	11M1120	89041120	44.09	11M1550	89041550	61.02	11M2120	89042120	83.46
11M850	89040850	33.46	11M1150	89041150	45.28	11M1600	89041600	62.99	11M2180	89042180	85.83
11M875	89040875	34.45	11M1180	89041180	46.46	11M1650	89041650	64.96	11M2240	89042240	88.19
11M900	89040900	35.43	11M1220	89041220	48.03	11M1700	89041700	66.93	11M2300	89042300	90.55
11M925	89040925	36.42	11M1250	89041250	49.21	11M1750	89041750	68.9			
11M950	89040950	37.4	11M1280	89041280	50.39	11M1800	89041800	70.87			

BANDAS POLIFLEX® JB®

La construcción de las bandas JB (Joined Belt= banda unida) proporciona estabilidad de operación, lo que evita que pudieran voltearse o salirse de la transmisión. Única con ángulo de 60°, construcción de poliuretano para altas cargas y velocidades, en transmisiones más esbeltas que las convencionales con bandas V.

MERCADOS/APLICACIONES

Usar en lugar de las Polyflex® sencillas en transmisiones que las requieran en combo. Algunas de las aplicaciones incluyen máquinas herramienta, periféricos computacionales, equipo médico, pequeños instrumentos, soplador de transmisiones y mezcladores de masas.

CARACTERÍSTICAS/VENTAJAS

- Alto módulo de los compuestos de poliuretano que resisten fatiga, uso, ozono y demás condiciones ambientales.
- El proceso de fabricación es una sola colada, lo cual elimina la vibración.
- Su dorso dentado proporciona excelente estabilidad lateral y suaviza el esfuerzo al circular por poleas de diámetros pequeños.
- Trabaja en rangos de temperatura: -54°C a +85°C (-65°F a 180°F)
- La construcción unida de la banda proporciona alta estabilidad, previniendo que la banda se voltee o se salga.

Poleas recomendadas: Poleas Polyflex®.

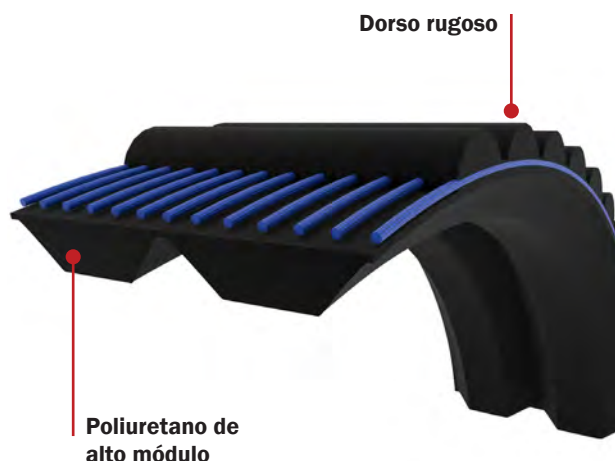

Notas: Las bandas Polyflex JB están disponibles en 3M, 5M, 7M, y 11M. El número de parte de la banda Polyflex JB está comprendido del número de bandas unidas, longitud efectiva y "JB" que significan construcción Joined Band. Por ejemplo, la nomenclatura de la 3/5M1000JB representa 3 bandas unidas, 5mm de ancho por cada una con longitud efectiva de 1000mm (JB). Puede aplicar tiempos de entrega para bandas con más costillas de las listadas. No aplica lote mínimo para bandas de longitudes listadas.



BANDA POLYFLEX® JB®

3M

PRODUCTO	CÓDIGO	PESO (LBS.)	PRODUCTO	CÓDIGO	PESO (LBS.)	PRODUCTO	CÓDIGO	PESO (LBS.)	PRODUCTO	CÓDIGO	PESO (LBS.)
2/3M175JB	89112175	6.74	3/3M250JB	89113250	9.69	2/3M365JB	89112365	14.22	3/3M530JB	89113530	20.72
3/3M175JB	89113175	6.74	2/3M258JB	89112258	10.01	3/3M365JB	89113365	14.22	2/3M545JB	89112545	21.31
2/3M180JB	89112180	6.94	3/3M258JB	89113258	10.01	2/3M375JB	89112375	14.61	3/3M545JB	89113545	21.31
3/3M180JB	89113180	6.94	2/3M265JB	89112265	10.28	3/3M375JB	89113375	14.61	2/3M560JB	89112560	21.9
2/3M185JB	89112185	7.13	3/3M265JB	89113265	10.28	2/3M387JB	89112387	15.09	3/3M560JB	89113560	21.9
3/3M185JB	89113185	7.13	2/3M272JB	89112272	10.56	3/3M387JB	89113387	15.09	2/3M580JB	89112580	22.69
2/3M190JB	89112190	7.33	3/3M272JB	89113272	10.56	2/3M400JB	89112400	15.6	3/3M580JB	89113580	22.69
3/3M190JB	89113190	7.33	2/3M280JB	89112280	10.87	3/3M400JB	89113400	15.6	2/3M600JB	89112600	23.47
2/3M195JB	89112195	7.53	3/3M280JB	89113280	10.87	2/3M412JB	89112412	16.07	3/3M600JB	89113600	23.47



BANDA POLYFLEX® JB®

3M

PRODUCTO	CÓDIGO	PESO (LBS.)	PRODUCTO	CÓDIGO	PESO (LBS.)	PRODUCTO	CÓDIGO	PESO (LBS.)	PRODUCTO	CÓDIGO	PESO (LBS.)
3/3M195JB	89113195	7.53	2/3M290JB	89112290	11.27	3/3M412JB	89113412	16.07	2/3M615JB	89112615	24.06
2/3M200JB	89112200	7.72	3/3M290JB	89113290	11.27	2/3M425JB	89112425	15.68	3/3M615JB	89113615	24.06
3/3M200JB	89113200	7.72	2/3M300JB	89112300	11.66	3/3M425JB	89113425	15.68	2/3M630JB	89112630	24.65
2/3M206JB	89112206	7.96	3/3M300JB	89113300	11.66	2/3M437JB	89112437	17.06	3/3M630JB	89113630	24.65
3/3M206JB	89113206	7.96	2/3M307JB	89112307	11.94	3/3M437JB	89113437	17.06	2/3M650JB	89112650	25.44
2/3M212JB	89112212	8.2	3/3M307JB	89113307	11.94	2/3M450JB	89112450	17.57	3/3M650JB	89113650	25.44
3/3M212JB	89113212	8.2	2/3M315JB	89112315	12.25	3/3M450JB	89113450	17.57	2/3M670JB	89112670	26.23
2/3M218JB	89112218	8.43	3/3M315JB	89113315	12.25	2/3M462JB	89112462	18.04	3/3M670JB	89113670	26.23
3/3M218JB	89113218	8.43	2/3M325JB	89112325	12.65	3/3M462JB	89113462	18.04	2/3M690JB	89112690	27.01
2/3M224JB	89112224	8.67	3/3M325JB	89113325	12.65	2/3M475JB	89112475	18.55	3/3M690JB	89113690	27.01
3/3M224JB	89113224	8.67	2/3M335JB	89112335	13.04	3/3M475JB	89113475	18.55	2/3M710JB	89112710	27.8
2/3M230JB	89112230	8.91	3/3M335JB	89113335	13.04	2/3M487JB	89112487	19.02	3/3M710JB	89113710	27.8
3/3M230JB	89113230	8.91	2/3M345JB	89112345	13.43	3/3M487JB	89113487	19.02	2/3M730JB	89112730	28.59
2/3M236JB	89112236	9.14	3/3M345JB	89113345	13.43	2/3M500JB	89112500	19.54	3/3M730JB	89113730	28.59
3/3M236JB	89113236	9.14	2/3M350JB	89112350	13.63	3/3M500JB	89113500	19.54	2/3M750JB	89112750	29.38
2/3M243JB	89112243	9.42	3/3M350JB	89113350	13.63	2/3M515JB	89112515	20.13	3/3M750JB	89113750	29.38
3/3M243JB	89113243	9.42	2/3M355JB	89112355	13.83	3/3M515JB	89113515	20.13			
2/3M250JB	89112250	9.69	3/3M355JB	89113355	13.83	2/3M530JB	89112530	20.72			

BANDA POLYFLEX® JB®

5M

PRODUCTO	CÓDIGO	PESO (LBS.)	PRODUCTO	CÓDIGO	PESO (LBS.)	PRODUCTO	CÓDIGO	PESO (LBS.)	PRODUCTO	CÓDIGO	PESO (LBS.)
2/5M280JB	89122280	11.02	4/5M437JB	89124437	17.2	2/5M690JB	89122690	27.17	2/5M1090JB	89122109	42.91
3/5M280JB	89123280	11.02	5/5M437JB	89125437	17.2	3/5M690JB	89123690	27.17	3/5M1090JB	89123109	42.91
4/5M280JB	89124280	11.02	2/5M450JB	89122450	17.72	4/5M690JB	89124690	27.17	4/5M1090JB	89124109	42.91
5/5M280JB	89125280	11.02	3/5M450JB	89123450	17.72	5/5M690JB	89125690	27.17	5/5M1090JB	89125109	42.91
2/5M290JB	89122290	11.42	4/5M450JB	89124450	17.72	2/5M710JB	89122710	27.95	2/5M1120JB	89122112	44.09
3/5M290JB	89123290	11.42	5/5M450JB	89125450	17.72	3/5M710JB	89123710	27.95	3/5M1120JB	89123112	44.09
4/5M290JB	89124290	11.42	2/5M462JB	89122462	18.19	4/5M710JB	89124710	27.95	4/5M1120JB	89124112	44.09
5/5M290JB	89125290	11.42	3/5M462JB	89123462	18.19	5/5M710JB	89125710	27.95	5/5M1120JB	89125112	44.09
2/5M300JB	89122300	11.81	4/5M462JB	89124462	18.19	2/5M730JB	89122730	28.74	2/5M1150JB	89122115	45.28
3/5M300JB	89123300	11.81	5/5M462JB	89125462	18.19	3/5M730JB	89123730	28.74	3/5M1150JB	89123115	45.28
4/5M300JB	89124300	11.81	2/5M475JB	89122475	18.7	4/5M730JB	89124730	28.74	4/5M1150JB	89124115	45.28
5/5M300JB	89125300	11.81	3/5M475JB	89123475	18.7	5/5M730JB	89125730	28.74	5/5M1150JB	89125115	45.28
2/5M307JB	89122307	12.09	4/5M475JB	89124475	18.7	2/5M750JB	89122750	29.53	2/5M1180JB	89122118	46.46
3/5M307JB	89123307	12.09	5/5M475JB	89125475	18.7	3/5M750JB	89123750	29.53	3/5M1180JB	89123118	46.46
4/5M307JB	89124307	12.09	2/5M487JB	89122487	19.17	4/5M750JB	89124750	29.53	4/5M1180JB	89124118	46.46

BANDAS POLYFLEX® JB®

BANDA POLYFLEX® JB®

5M

PRODUCTO	CÓDIGO	PESO (LBS.)	PRODUCTO	CÓDIGO	PESO (LBS.)	PRODUCTO	CÓDIGO	PESO (LBS.)	PRODUCTO	CÓDIGO	PESO (LBS.)
5/5M307JB	89125307	12.09	3/5M487JB	89123487	19.17	5/5M750JB	89125750	29.53	5/5M1180JB	89125118	46.46
2/5M315JB	89122315	12.4	4/5M487JB	89124487	19.17	2/5M775JB	89122775	30.51	2/5M1220JB	89122122	48.03
3/5M315JB	89123315	12.4	5/5M487JB	89125487	19.17	3/5M775JB	89123775	30.51	3/5M1220JB	89123122	48.03
4/5M315JB	89124315	12.4	2/5M500JB	89122500	19.69	4/5M775JB	89124775	30.51	4/5M1220JB	89124122	48.03
5/5M315JB	89125315	12.4	3/5M500JB	89123500	19.69	5/5M775JB	89125775	30.51	5/5M1220JB	89125122	48.03
2/5M325JB	89122325	12.8	4/5M500JB	89124500	19.69	2/5M800JB	89122800	31.5	2/5M1250JB	89122125	49.21
3/5M325JB	89123325	12.8	5/5M500JB	89125500	19.69	3/5M800JB	89123800	31.5	3/5M1250JB	89123125	49.21
4/5M325JB	89124325	12.8	2/5M515JB	89122515	20.28	4/5M800JB	89124800	31.5	4/5M1250JB	89124125	49.21
5/5M325JB	89125325	12.8	3/5M515JB	89123515	20.28	5/5M800JB	89125800	31.5	5/5M1250JB	89125125	49.21
2/5M335JB	89122335	13.19	4/5M515JB	89124515	20.28	2/5M825JB	89122825	32.48	2/5M1280JB	89122128	50.39
3/5M335JB	89123335	13.19	5/5M515JB	89125515	20.28	3/5M825JB	89123825	32.48	3/5M1280JB	89123128	50.39
4/5M335JB	89124335	13.19	2/5M530JB	89122530	20.87	4/5M825JB	89124825	32.48	4/5M1280JB	89124128	50.39
5/5M335JB	89125335	13.19	3/5M530JB	89123530	20.87	5/5M825JB	89125825	32.48	5/5M1280JB	89125128	50.39
2/5M345JB	89122345	13.58	4/5M530JB	89124530	20.87	2/5M850JB	89122850	33.46	2/5M1320JB	89122132	51.97
3/5M345JB	89123345	13.58	5/5M530JB	89125530	20.87	3/5M850JB	89123850	33.46	3/5M1320JB	89123132	51.97
4/5M345JB	89124345	13.58	2/5M545JB	89122545	21.46	4/5M850JB	89124850	33.46	4/5M1320JB	89124132	51.97
5/5M345JB	89125345	13.58	3/5M545JB	89123545	21.46	5/5M850JB	89125850	33.46	5/5M1320JB	89125132	51.97
2/5M355JB	89122355	13.98	4/5M545JB	89124545	21.46	2/5M875JB	89122875	34.45	2/5M1360JB	89122136	53.54
3/5M355JB	89123355	13.98	5/5M545JB	89125545	21.46	3/5M875JB	89123875	34.45	3/5M1360JB	89123136	53.54
4/5M355JB	89124355	13.98	2/5M560JB	89122560	22.05	4/5M875JB	89124875	34.45	4/5M1360JB	89124136	53.54
5/5M355JB	89125355	13.98	3/5M560JB	89123560	22.05	5/5M875JB	89125875	34.45	5/5M1360JB	89125136	53.54
2/5M365JB	89122365	14.37	4/5M560JB	89124560	22.05	2/5M900JB	89122900	35.43	2/5M1400JB	89122140	55.12
3/5M365JB	89123365	14.37	5/5M560JB	89125560	22.05	3/5M900JB	89123900	35.43	3/5M1400JB	89123140	55.12
4/5M365JB	89124365	14.37	2/5M580JB	89122580	22.83	4/5M900JB	89124900	35.43	4/5M1400JB	89124140	55.12
5/5M365JB	89125365	14.37	3/5M580JB	89123580	22.83	5/5M900JB	89125900	35.43	5/5M1400JB	89125140	55.12
2/5M375JB	89122375	14.76	4/5M580JB	89124580	22.83	2/5M925JB	89122925	36.42	2/5M1450JB	89122145	57.09
3/5M375JB	89123375	14.76	5/5M580JB	89125580	22.83	3/5M925JB	89123925	36.42	3/5M1450JB	89123145	57.09
4/5M375JB	89124375	14.76	2/5M600JB	89122600	23.62	4/5M925JB	89124925	36.42	4/5M1450JB	89124145	57.09
5/5M375JB	89125375	14.76	3/5M600JB	89123600	23.62	5/5M925JB	89125925	36.42	5/5M1450JB	89125145	57.09
2/5M387JB	89122387	15.24	4/5M600JB	89124600	23.62	2/5M950JB	89122950	37.4	2/5M1500JB	89122150	59.06
3/5M387JB	89123387	15.24	5/5M600JB	89125600	23.62	3/5M950JB	89123950	37.4	3/5M1500JB	89123150	59.06
4/5M387JB	89124387	15.24	2/5M615JB	89122615	24.21	4/5M950JB	89124950	37.4	4/5M1500JB	89120001	59.06
5/5M387JB	89125387	15.24	3/5M615JB	89123615	24.21	5/5M950JB	89125950	37.4	5/5M1500JB	89125150	59.06
2/5M400JB	89122400	15.75	4/5M615JB	89124615	24.21	2/5M975JB	89122975	38.39			
3/5M400JB	89123400	15.75	5/5M615JB	89125615	24.21	3/5M975JB	89123975	38.39			
4/5M400JB	89124400	15.75	2/5M630JB	89122630	24.8	4/5M975JB	89124975	38.39			
5/5M400JB	89125400	15.75	3/5M630JB	89123630	24.8	5/5M975JB	89125975	38.39			

BANDA POLYFLEX® JB®

5M

PRODUCTO	CÓDIGO	PESO (LBS.)	PRODUCTO	CÓDIGO	PESO (LBS.)	PRODUCTO	CÓDIGO	PESO (LBS.)
2/5M412JB	89122412	16.22	4/5M630JB	89124630	24.8	2/5M1000JB	89122100	39.37
3/5M412JB	89123412	16.22	5/5M630JB	89125630	24.8	3/5M1000JB	89123100	39.37
4/5M412JB	89124412	16.22	2/5M650JB	89122650	25.59	4/5M1000JB	89124100	39.37
5/5M412JB	89125412	16.22	3/5M650JB	89123650	25.59	5/5M1000JB	89125100	39.37
2/5M425JB	89122425	16.73	4/5M650JB	89124650	25.59	2/5M1030JB	89122103	40.55
3/5M425JB	89123425	16.73	5/5M650JB	89125650	25.59	3/5M1030JB	89123103	40.55
4/5M425JB	89124425	16.73	2/5M670JB	89122670	26.38	4/5M1030JB	89124103	40.55
5/5M425JB	89125425	16.73	3/5M670JB	89123670	26.38	5/5M1030JB	89125103	40.55
2/5M437JB	89122437	17.2	4/5M670JB	89124670	26.38	2/5M1060JB	89122106	41.73
3/5M437JB	89123437	17.2	5/5M670JB	89125670	26.38	3/5M1060JB	89123106	41.73

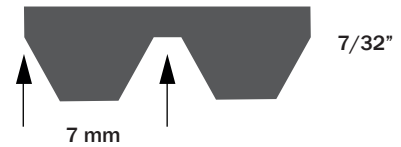

BANDA POLYFLEX® JB®

7M

PRODUCTO	CÓDIGO	PESO (LBS.)	PRODUCTO	CÓDIGO	PESO (LBS.)	PRODUCTO	CÓDIGO	PESO (LBS.)	PRODUCTO	CÓDIGO	PESO (LBS.)
2/7M500JB	89132500	19.3	4/7M730JB	89134730	28.5	2/7M1090JB	89132109	42.7	4/7M1600JB	89134160	62.7
3/7M500JB	89133500	19.3	5/7M730JB	89135730	28.5	3/7M1090JB	89133109	42.7	5/7M1600JB	89135160	62.7
4/7M500JB	89134500	19.3	2/7M750JB	89132750	29.3	4/7M1090JB	89134109	42.7	2/7M1650JB	89132165	64.7
5/7M500JB	89135500	19.3	3/7M750JB	89133750	29.3	5/7M1090JB	89135109	42.7	3/7M1650JB	89133165	64.7
2/7M515JB	89132515	19.9	4/7M750JB	89134750	29.3	2/7M1120JB	89132112	43.8	4/7M1650JB	89134165	64.7
3/7M515JB	89133515	19.9	5/7M750JB	89135750	29.3	3/7M1120JB	89133112	43.8	5/7M1650JB	89135165	64.7
4/7M515JB	89134515	19.9	2/7M775JB	89132775	30.3	4/7M1120JB	89134112	43.8	2/7M1700JB	89132170	66.7
5/7M515JB	89135515	19.9	3/7M775JB	89133775	30.3	5/7M1120JB	89135112	43.8	3/7M1700JB	89133170	66.7
2/7M530JB	89132530	20.5	4/7M775JB	89134775	30.3	2/7M1150JB	89132115	45	4/7M1700JB	89134170	66.7
3/7M530JB	89133530	20.5	5/7M775JB	89135775	30.3	3/7M1150JB	89133115	45	5/7M1700JB	89135170	66.7
4/7M530JB	89134530	20.5	2/7M800JB	89132800	31.2	4/7M1150JB	89134115	45	2/7M1750JB	89132175	68.6
5/7M530JB	89135530	20.5	3/7M800JB	89133800	31.2	5/7M1150JB	89135115	45	3/7M1750JB	89133175	68.6
2/7M545JB	89132545	21.1	4/7M800JB	89134800	31.2	2/7M1180JB	89132118	46.2	4/7M1750JB	89134175	68.6
3/7M545JB	89133545	21.1	5/7M800JB	89135800	31.2	3/7M1180JB	89133118	46.2	5/7M1750JB	89135175	68.6
4/7M545JB	89134545	21.1	2/7M825JB	89132825	32.2	4/7M1180JB	89134118	46.2	2/7M1800JB	89132180	70.6
5/7M545JB	89135545	21.1	3/7M825JB	89133825	32.2	5/7M1180JB	89135118	46.2	3/7M1800JB	89133180	70.6
2/7M560JB	89132560	21.6	4/7M825JB	89134825	32.2	2/7M1220JB	89132122	47.8	4/7M1800JB	89134180	70.6
3/7M560JB	89133560	21.6	5/7M825JB	89135825	32.2	3/7M1220JB	89133122	47.8	5/7M1800JB	89135180	70.6
4/7M560JB	89134560	21.6	2/7M850JB	89132850	33.2	4/7M1220JB	89134122	47.8	2/7M1850JB	89132185	72.6
5/7M560JB	89135560	21.6	3/7M850JB	89133850	33.2	5/7M1220JB	89135122	47.8	3/7M1850JB	89133185	72.6
2/7M580JB	89132580	22.4	4/7M850JB	89134850	33.2	2/7M1250JB	89132125	49	4/7M1850JB	89134185	72.6
3/7M580JB	89133580	22.4	5/7M850JB	89135850	33.2	3/7M1250JB	89133125	49	5/7M1850JB	89135185	72.6
4/7M580JB	89134580	22.4	2/7M875JB	89132875	34.2	4/7M1250JB	89134125	49	2/7M1900JB	89132190	74.6

BANDAS POLYFLEX® JB®

BANDA POLYFLEX® JB®

7M

PRODUCTO	CÓDIGO	PESO (LBS.)	PRODUCTO	CÓDIGO	PESO (LBS.)	PRODUCTO	CÓDIGO	PESO (LBS.)	PRODUCTO	CÓDIGO	PESO (LBS.)
5/7M580JB	89135580	22.4	3/7M875JB	89133875	34.2	5/7M1250JB	89135125	49	3/7M1900JB	89133190	74.6
2/7M600JB	89132600	23.2	4/7M875JB	89134875	34.2	2/7M1280JB	89132128	50.1	4/7M1900JB	89134190	74.6
3/7M600JB	89133600	23.2	5/7M875JB	89135875	34.2	3/7M1280JB	89133128	50.1	5/7M1900JB	89135190	74.6
4/7M600JB	89134600	23.2	2/7M900JB	89132900	35.2	4/7M1280JB	89134128	50.1	2/7M1950JB	89132195	76.5
5/7M600JB	89135600	23.2	3/7M900JB	89133900	35.2	5/7M1280JB	89135128	50.1	3/7M1950JB	89133195	76.5
2/7M615JB	89132615	23.8	4/7M900JB	89134900	35.2	2/7M1320JB	89132132	51.7	4/7M1950JB	89134195	76.5
3/7M615JB	89133615	23.8	5/7M900JB	89135900	35.2	3/7M1320JB	89133132	51.7	5/7M1950JB	89135195	76.5
4/7M615JB	89134615	23.8	2/7M925JB	89132925	36.2	4/7M1320JB	89134132	51.7	2/7M2000JB	89132200	78.5
5/7M615JB	89135615	23.8	3/7M925JB	89133925	36.2	5/7M1320JB	89135132	51.7	3/7M2000JB	89133200	78.5
2/7M630JB	89132630	24.4	4/7M925JB	89134925	36.2	2/7M1360JB	89132136	53.3	4/7M2000JB	89134200	78.5
3/7M630JB	89133630	24.4	5/7M925JB	89135925	36.2	3/7M1360JB	89133136	53.3	5/7M2000JB	89135200	78.5
4/7M630JB	89134630	24.4	2/7M950JB	89132950	37.2	4/7M1360JB	89134136	53.3	2/7M2060JB	89132206	80.9
5/7M630JB	89135630	24.4	3/7M950JB	89133950	37.2	5/7M1360JB	89135136	53.3	3/7M2060JB	89133206	80.9
2/7M650JB	89132650	25.2	4/7M950JB	89134950	37.2	2/7M1400JB	89132140	54.9	4/7M2060JB	89134206	80.9
3/7M650JB	89133650	25.2	5/7M950JB	89135950	37.2	3/7M1400JB	89133140	54.9	5/7M2060JB	89135206	80.9
4/7M650JB	89134650	25.2	2/7M975JB	89132975	38.1	4/7M1400JB	89134140	54.9	2/7M2120JB	89132212	83.2
5/7M650JB	89135650	25.2	3/7M975JB	89133975	38.1	5/7M1400JB	89135140	54.9	3/7M2120JB	89133212	83.2
2/7M670JB	89132670	26	4/7M975JB	89134975	38.1	2/7M1450JB	89132145	56.8	4/7M2120JB	89134212	83.2
3/7M670JB	89133670	26	5/7M975JB	89135975	38.1	3/7M1450JB	89133145	56.8	5/7M2120JB	89135212	83.2
4/7M670JB	89134670	26	2/7M1000JB	89132100	39.1	4/7M1450JB	89134145	56.8	2/7M2180JB	89132218	85.6
5/7M670JB	89135670	26	3/7M1000JB	89133100	39.1	5/7M1450JB	89135145	56.8	3/7M2180JB	89133218	85.6
2/7M690JB	89132690	26.8	4/7M1000JB	89134100	39.1	2/7M1500JB	89132150	58.8	4/7M2180JB	89134218	85.6
3/7M690JB	89133690	26.8	5/7M1000JB	89135100	39.1	3/7M1500JB	89133150	58.8	5/7M2180JB	89135218	85.6
4/7M690JB	89134690	26.8	2/7M1030JB	89132103	40.3	4/7M1500JB	89134150	58.8	2/7M2240JB	89132224	87.9
5/7M690JB	89135690	26.8	3/7M1030JB	89133103	40.3	5/7M1500JB	89135150	58.8	3/7M2240JB	89133224	87.9
2/7M710JB	89132710	27.7	4/7M1030JB	89134103	40.3	2/7M1550JB	89132155	60.8	4/7M2240JB	89134224	87.9
3/7M710JB	89133710	27.7	5/7M1030JB	89135103	40.3	3/7M1550JB	89133155	60.8	5/7M2240JB	89135224	87.9
4/7M710JB	89134710	27.7	2/7M1060JB	89132106	41.5	4/7M1550JB	89134155	60.8	2/7M2300JB	89132230	90.3
5/7M710JB	89135710	27.7	3/7M1060JB	89133106	41.5	5/7M1550JB	89135155	60.8	3/7M2300JB	89133230	90.3
2/7M730JB	89132730	28.5	4/7M1060JB	89134106	41.5	2/7M1600JB	89132160	62.7	4/7M2300JB	89134230	90.3
3/7M730JB	89133730	28.5	5/7M1060JB	89135106	41.5	3/7M1600JB	89133160	62.7	5/7M2300JB	89135230	90.3

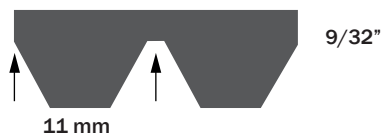

BANDA POLYFLEX® JB®

11M

PRODUCTO	CÓDIGO	PESO (LBS.)	PRODUCTO	CÓDIGO	PESO (LBS.)	PRODUCTO	CÓDIGO	PESO (LBS.)
2/11M710JB	89142710	27.3	2/11M1060JB	89142106	41	2/11M1600JB	89142160	62.3
3/11M710JB	89143710	27.3	3/11M1060JB	89143106	41	3/11M1600JB	89143160	62.3
2/11M730JB	89142730	28	2/11M1090JB	89142109	42.2	2/11M1650JB	89142165	64.3

BANDAS POLYFLEX® JB®

BANDA POLYFLEX® JB®

11M

PRODUCTO	CÓDIGO	PESO (LBS.)	PRODUCTO	CÓDIGO	PESO (LBS.)	PRODUCTO	CÓDIGO	PESO (LBS.)
3/11M730JB	89143730	28	3/11M1090JB	89143109	42.2	3/11M1650JB	89143165	64.3
2/11M750JB	89142750	28.8	2/11M1120JB	89142112	43.4	2/11M1700JB	89142170	66.2
3/11M750JB	89143750	28.8	3/11M1120JB	89143112	43.4	3/11M1700JB	89143170	66.2
2/11M775JB	89142775	29.8	2/11M1150JB	89142115	44.6	2/11M1750JB	89142175	68.2
3/11M775JB	89143775	29.8	3/11M1150JB	89143115	44.6	3/11M1750JB	89143175	68.2
2/11M800JB	89142800	30.8	2/11M1180JB	89142118	45.8	2/11M1800JB	89142180	70.2
3/11M800JB	89143800	30.8	3/11M1180JB	89143118	45.8	3/11M1800JB	89143180	70.2
2/11M825JB	89142825	31.8	2/11M1220JB	89142122	47.3	2/11M1850JB	89142185	72.1
3/11M825JB	89143825	31.8	3/11M1220JB	89143122	47.3	3/11M1850JB	89143185	72.1
2/11M850JB	89142850	32.8	2/11M1250JB	89142125	48.5	2/11M1900JB	89142190	74.1
3/11M850JB	89143850	32.8	3/11M1250JB	89143125	48.5	3/11M1900JB	89143190	74.1
2/11M875JB	89142875	33.7	2/11M1280JB	89142128	49.7	2/11M1950JB	89142195	76.1
3/11M875JB	89143875	33.7	3/11M1280JB	89143128	49.7	3/11M1950JB	89143195	76.1
2/11M900JB	89142900	34.7	2/11M1320JB	89142132	51.3	2/11M2000JB	89142200	78
3/11M900JB	89143900	34.7	3/11M1320JB	89143132	51.3	3/11M2000JB	89143200	78
2/11M925JB	89142925	35.7	2/11M1360JB	89142136	52.8	2/11M2060JB	89142206	80.4
3/11M925JB	89143925	35.7	3/11M1360JB	89143136	52.8	3/11M2060JB	89143206	80.4
2/11M950JB	89142950	36.7	2/11M1400JB	89142140	54.4	2/11M2120JB	89142212	82.8
3/11M950JB	89143950	36.7	3/11M1400JB	89143140	54.4	3/11M2120JB	89143212	82.8
2/11M975JB	89142975	37.7	2/11M1450JB	89142145	56.4	2/11M2180JB	89142218	85.1
3/11M975JB	89143975	37.7	3/11M1450JB	89143145	56.4	3/11M2180JB	89143218	85.1
2/11M1000JB	89142100	38.7	2/11M1500JB	89142150	58.4	2/11M2240JB	89142224	87.5
3/11M1000JB	89143100	38.7	3/11M1500JB	89143150	58.4	3/11M2240JB	89143224	87.5
2/11M1030JB	89142103	39.9	2/11M1550JB	89142155	60.3	2/11M2300JB	89142230	89.9
3/11M1030JB	89143103	39.9	3/11M1550JB	89143155	60.3	3/11M2300JB	89143230	89.9

BANDAS SUPER HC®

DENTADA MOLDEADA

Construida con materiales patentados por Gates, esta banda posee una combinación superior flexible y capacidad de transporte de carga, así como también transmitir más caballos de fuerza que las secciones clásicas en el mismo espacio de la transmisión.

MERCADOS/APLICACIONES

La mejor opción para todo tipo de aplicaciones industriales, particularmente donde espacio, peso y carga son críticos.

CARACTERÍSTICAS/VENTAJAS

- Su dentado moldeado especial hace de esta banda la mejor opción para transmisiones con poleas de diámetros grandes y pequeños.
- El filo de la banda es maquinado para mayor contacto con la ranura de la polea, resultando en menor deslizamiento.
- Sus cuerdas son unidas flexiblemente al cuerpo de la banda para una distribución uniforme de la carga.
- Satisface los estándares de resistencia al petróleo y calor.
- Satisface los requerimientos RMA de conductividad estática.

Curvas Gates®

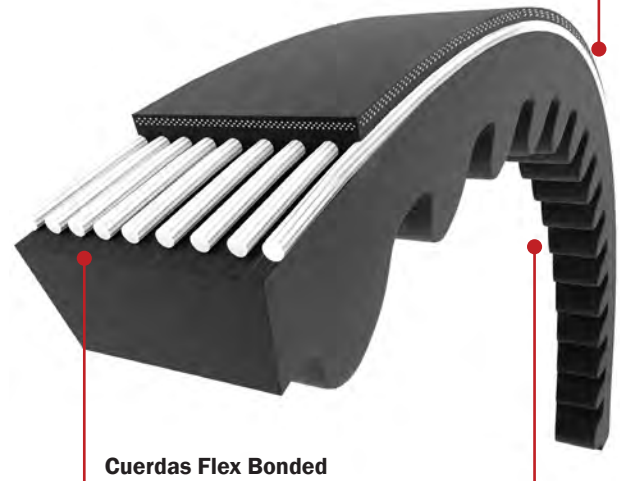

Cuerdas Flex Bonded

Dentado moldeado especial

Poleas recomendadas: Poleas Super HC®

Notas: Las bandas dentadas moldeadas Gates Super HC® están disponibles en 3VX y 5VX, secciones cruzadas.



BANDA SUPER HC® DENTADA MOLDEADA

SECCIÓN 3VX

DESCRIPCIÓN	CÓDIGO	LONG. (PULG.)	PESO (LBS.)	DESCRIPCIÓN	CÓDIGO	LONG. (PULG.)	PESO (LBS.)
3VX250	94120250	25	0.11	3VX375	94120375	37.5	0.16
3VX265	94120265	26.5	0.12	3VX385	94120385	38.5	0.16
3VX280	94120280	28	0.13	3VX390	94120390	39	0.16
3VX290	94120290	29	0.13	3VX400	94120400	40	0.17
3VX300	94120300	30	0.13	3VX415	94120415	41.5	0.17
3VX315	94120315	31.5	0.14	3VX425	94120425	42.5	0.18
3VX326	94120326	32.6	0.14	3VX450	94120450	45	0.19
3VX335	94120335	33.5	0.14	3VX464	94120464	46.4	0.2
3VX350	94120350	35	0.17	3VX475	94120475	47.5	0.2
3VX355	94120355	35.5	0.15	3VX487	94120487	48.7	0.2
3VX366	94120366	36.6	0.16	3VX500	94120500	50	0.2

BANDA SUPER HC® DENTADA MOLDEADA**SECCIÓN 3VX**

DESCRIPCIÓN	CÓDIGO	LONG. (PULG.)	PESO (LBS.)	DESCRIPCIÓN	CÓDIGO	LONG. (PULG.)	PESO (LBS.)
3VX520	94120520	52	0.21	3VX826	94120826	82.6	0.32
3VX530	94120530	53	0.21	3VX850	94120850	85	0.33
3VX540	94120540	54	0.22	3VX900	94120900	90	0.35
3VX550	94120550	55	0.22	3VX926	94120926	92.6	0.35
3VX560	94120560	56	0.23	3VX950	94120950	95	0.37
3VX570	94120570	57	0.23	3VX974	94120974	97.4	0.37
3VX580	94120580	58	0.23	3VX1000	94121000	100	0.38
3VX590	94120590	59	0.24	3VX1027	94121027	102.7	0.39
3VX600	94120600	60	0.24	3VX1060	94121060	106	0.41
3VX616	94120616	61.6	0.25	3VX1088	94121088	108.8	0.42
3VX630	94120630	63	0.25	3VX1120	94121120	112	0.43
3VX650	94120650	65	0.26	3VX1146	94121146	114.6	0.44
3VX670	94120670	67	0.27	3VX1180	94121180	118	0.45
3VX690	94120690	69	0.27	3VX1224	94121224	122.4	0.47
3VX710	94120710	71	0.28	3VX1250	94121250	125	0.47
3VX750	94120750	75	0.29	3VX1296	94121296	129.6	0.49
3VX771	94120771	77.1	0.3	3VX1320	94121320	132	0.5
3VX800	94120800	80	0.31	3VX1400	94121400	140	0.53

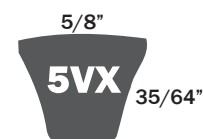
**SECCIÓN 5VX**

DESCRIPCIÓN	CÓDIGO	LONG. (PULG.)	PESO (LBS.)	DESCRIPCIÓN	CÓDIGO	LONG. (PULG.)	PESO (LBS.)
5VX350	94140350	35	0.36	5VX550	94140550	55	0.56
5VX362	94140362	36.2	0.37	5VX560	94140560	56	0.57
5VX372	94140372	37.2	0.38	5VX570	94140570	57	0.58
5VX382	94140382	38.2	0.4	5VX580	94140580	58	0.59
5VX392	94140392	39.2	0.4	5VX590	94140590	59	0.6
5VX402	94140402	40.2	0.41	5VX600	94140600	60	0.6
5VX412	94140412	41.2	0.42	5VX610	94140610	61	0.61
5VX422	94140422	42.2	0.43	5VX619	94140619	61.9	0.62
5VX433	94140433	43.3	0.45	5VX630	94140630	63	0.64
5VX450	94140450	45	0.46	5VX650	94140650	65	0.66
5VX459	94140459	45.9	0.46	5VX660	94140660	66	0.66
5VX470	94140470	47	0.48	5VX670	94140670	67	0.68
5VX479	94140479	47.9	0.49	5VX680	94140680	68	0.68
5VX490	94140490	49	0.5	5VX690	94140690	69	0.68
5VX500	94140500	50	0.51	5VX700	94140700	70	0.7
5VX510	94140510	51	0.52	5VX710	94140710	71	0.71
5VX519	94140519	51.9	0.54	5VX720	94140720	72	0.72
5VX530	94140530	53	0.54	5VX730	94140730	73	0.74
5VX540	94140540	54	0.55	5VX740	94140740	74	0.75

SECCIÓN 5VX

DESCRIPCIÓN	CÓDIGO	LONG. (PULG.)	PESO (LBS.)	DESCRIPCIÓN	CÓDIGO	LONG. (PULG.)	PESO (LBS.)
5VX750	94140750	75	0.76	5VX1050	94141050	105	1.05
5VX760	94140760	76	0.76	5VX1060	94141060	106	1.06
5VX769	94140769	76.9	0.77	5VX1080	94141080	108	1.07
5VX780	94140780	78	0.78	5VX1108	94141108	110.8	1.1
5VX790	94140790	79	0.8	5VX1120	94141120	112	1.11
5VX800	94140800	80	0.81	5VX1139	94141139	113.9	1.14
5VX810	94140810	81	0.82	5VX1150	94141150	115	1.14
5VX830	94140830	83	0.83	5VX1160	94141160	116	1.15
5VX840	94140840	84	0.84	5VX1162	94141162	116.2	1.15
5VX850	94140850	85	0.85	5VX1180	94141180	118	1.17
5VX860	94140860	86	0.86	5VX1220	94141220	122	1.2
5VX867	94140867	86.7	0.86	5VX1230	94141230	123	1.22
5VX880	94140880	88	0.89	5VX1250	94141250	125	1.24
5VX890	94140890	89	0.9	5VX1277	94141277	127.7	1.27
5VX900	94140900	90	0.9	5VX1320	94141320	132	1.3
5VX918	94140918	91.8	0.92	5VX1374	94141374	137.4	1.36
5VX930	94140930	93	0.93	5VX1400	94141400	140	1.38
5VX940	94140940	94	0.93	5VX1469	94141469	146.9	1.46
5VX950	94140950	95	0.95	5VX1500	94141500	150	1.48
5VX960	94140960	96	0.96	5VX1600	94141600	160	1.56
5VX978	94140978	97.8	0.98	5VX1700	94141700	170	1.67
5VX990	94140990	99	0.98	5VX1701	94141701	170.1	1.67
5VX1000	94141000	100	1	5VX1800	94141800	180	1.78
5VX1017	94141017	101.7	1.02	5VX1900	94141900	190	1.88
5VX1030	94141030	103	1.03	5VX2000	94142000	200	1.95

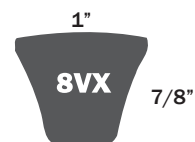

SECCIÓN 8VX

DESCRIPCIÓN	CÓDIGO	LONG. (PULG.)	PESO (LBS.)	DESCRIPCIÓN	CÓDIGO	LONG. (PULG.)	PESO (LBS.)
8VX1000	95161000	100	2.69	8VX1500	95161500	150	4.04
8VX1060	95161060	106	2.85	8VX1600	95161600	160	4.3
8VX1120	95161120	112	3.01	8VX1700	95161700	170	4.57
8VX1180	95161180	118	3.17	8VX1800	95161800	180	4.84
8VX1250	95161250	125	3.36	8VX1900	95161900	190	5.11
8VX1320	95161320	132	3.55	8VX2000	95162000	200	5.38
8VX1400	95161400	140	3.77				

BANDAS SUPER HC®

POWERBAND®

La construcción de las bandas PowerBand® permite funcionar varias bandas a la vez, con igual distribución de carga en cada una de ellas, trabajando con uniformidad en la ranura de la polea.

MERCADOS/APLICACIONES

Recomendado para transmisiones con poleas múltiples y que están expuestas a vibración o fuertes cargas de choque, las cuales pueden hacer que las bandas se volteen o brinquen en la transmisión.

CARACTERÍSTICAS/VENTAJAS

- La cubierta de la banda asegura alta rigidez lateral, guiando la banda en una línea derecha y previniendo su salto fuera de la transmisión.
- Las paredes laterales cóncavas proporcionan a la cuerda un fuerte soporte y máximo contacto con la ranura de la polea, además de distribuir uniformemente la carga en la misma.
- Sus cuerdas Flex-Bonded® están fuertemente unidas al cuerpo de la banda, con carga uniforme y la absorción de la fuerza de compresión a causa de poleas de diámetros pequeños sin que se deteriore la cuerda.
- Satisface los estándares de resistencia al petróleo y calor.
- Satisface los requerimientos RMA de conductividad estática.

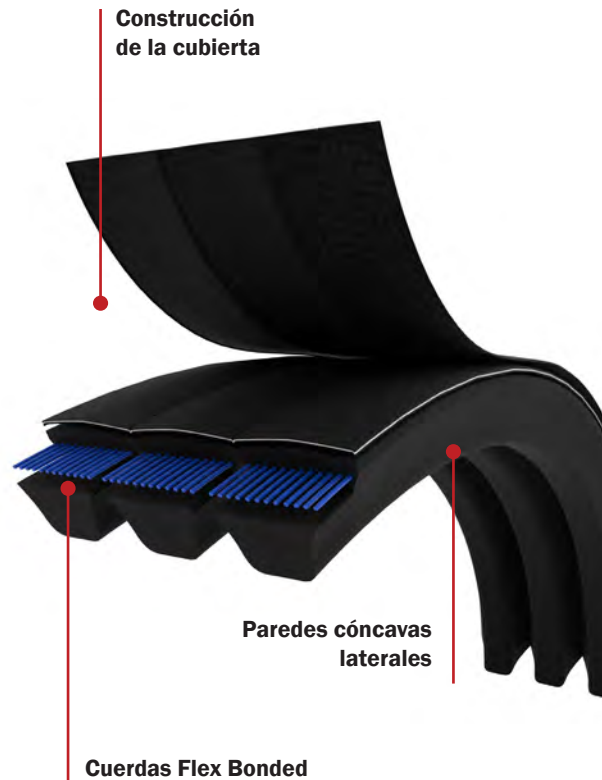

Notas: Orden con cantidad mínima no es requerida en longitudes listadas. Las bandas Super HC® Power Band® con seis bandas unidas, o más, pueden requerir mayor tiempo de entrega. El número de parte es constituido colocando el número de bandas unidas seguidas por una diagonal (/), además de la sección y tamaño de la banda. Por ejemplo 5/5V1400 representa 5 bandas unidas de la 5V1400.



Poleas recomendadas: Poleas Super HC®

BANDA SUPER HC® POWERBAND®

SECCIÓN A

BANDA (#=UNIDAS)	LONG. EXT. (PULG.)	PESO/BANDA (LBS.)	9174											13-30 BDAS. MÁX.
			2 BDAS.	3 BDAS.	4 BDAS.	5 BDAS.	6 BDAS.	7 BDAS.	8 BDAS.	9 BDAS.	10 BDAS.	11 BDAS.	12 BDAS.	
#/3V300	30.0	30.0	2030	3030	4030	5030	6030	7030	8030	9030	10030	11030	12030	##030
#/3V315	31.5	31.5	2031	3031	4031	5031	6031	7031	8031	9031	10031	11031	12031	##031
#/3V335	33.5	33.5	2033	3033	4033	5033	6033	7033	8033	9033	10033	11033	12033	##033
#/3V355	35.5	35.5	2035	3035	4035	5035	6035	7035	8035	9035	10035	11035	12035	##035
#/3V375	37.5	37.5	2037	3037	4037	5037	6037	7037	8037	9037	10037	11037	12037	##037
#/3V400	40.0	40.0	2040	3040	4040	5040	6040	7040	8040	9040	10040	11040	12040	##040

BANDA SUPER HC® POWERBAND®**SECCIÓN A**

BANDA (#=UNIDAS)	LONG. EXT. (PULG.)	PESO/ BANDA (LBS.)	9385											13-30 BANDAS MÁX.
			2 BDAS.	3 BDAS.	4 BDAS.	5 BDAS.	6 BDAS.	7 BDAS.	8 BDAS.	9 BDAS.	10 BDAS.	11 BDAS.	12 BDAS.	
#/3V425	42.5	42.5	2042	3042	4042	5042	6042	7042	8042	9042	10042	11042	12042	##042
#/3V450	45.0	45.0	2045	3045	4045	5045	6045	7045	8045	9045	10045	11045	12045	##045
#/3V475	47.5	47.5	2047	3047	4047	5047	6047	7047	8047	9047	10047	11047	12047	##047
#/3V500	50.0	50.0	2050	3050	4050	5050	6050	7050	8050	9050	10050	11050	12050	##050
#/3V530	53.0	53.0	2053	3053	4053	5053	6053	7053	8053	9053	10053	11053	12053	##053
#/3V560	56.0	56.0	2056	3056	4056	5056	6056	7056	8056	9056	10056	11056	12056	##056
#/3V600	60.0	60.0	2060	3060	4060	5060	6060	7060	8060	9060	10060	11060	12060	##060
#/3V630	63.0	63.0	2063	3063	4063	5063	6063	7063	8063	9063	10063	11063	12063	##063
#/3V670	67.0	67.0	2067	3067	4067	5067	6067	7067	8067	9067	10067	11067	12067	##067
#/3V710	71.0	71.0	2071	3071	4071	5071	6071	7071	8071	9071	10071	11071	12071	##071
#/3V750	75.0	75.0	2075	3075	4075	5075	6075	7075	8075	9075	10075	11075	12075	##075
#/3V800	80.0	80.0	2080	3080	4080	5080	6080	7080	8080	9080	10080	11080	12080	##080
#/3V850	85.0	85.0	2085	3085	4085	5085	6085	7085	8085	9085	10085	11085	12085	##085
#/3V900	90.0	90.0	2090	3090	4090	5090	6090	7090	8090	9090	10090	11090	12090	##090
#/3V950	95.0	95.0	2095	3095	4095	5095	6095	7095	8095	9095	10095	11095	12095	##095
#/3V1000	100.0	100.0	2100	3100	4100	5100	6100	7100	8100	9100	10100	11100	12100	##100
#/3V1060	106.0	106.0	2106	3106	4106	5106	6106	7106	8106	9106	10106	11106	12106	##106
#/3V1120	112.0	112.0	2112	3112	4112	5112	6112	7112	8112	9112	10112	11112	12112	##112
#/3V1180	118.0	118.0	2118	3118	4118	5118	6118	7118	8118	9118	10118	11118	12118	##118
#/3V1250	125.0	125.0	2125	3125	4125	5125	6125	7125	8125	9125	10125	11125	12125	##125
#/3V1320	132.0	132.0	2132	3132	4132	5132	6132	7132	8132	9132	10132	11132	12132	##132
#/3V1400	140.0	140.0	2140	3140	4140	5140	6140	7140	8140	9140	10140	11140	12140	##140

**BANDA SUPER HC® POWERBAND®****SECCIÓN 5V**

BANDA (#=UNIDAS)	LONG. EXT. (PULG.)	PESO/ BANDA (LBS.)	9386											13-30 BANDAS MÁX.
			2 BDAS.	3 BDAS.	4 BDAS.	5 BDAS.	6 BDAS.	7 BDAS.	8 BDAS.	9 BDAS.	10 BDAS.	11 BDAS.	12 BDAS.	
#/5V500	50.0	0.70	2050	3050	4050	5050	6050	7050	8050	9050	10050	11050	12050	##050
#/5V530	53.0	0.80	2053	3053	4053	5053	6053	7053	8053	9053	10053	11053	12053	##053
#/5V560	56.0	0.86	2056	3056	4056	5056	6056	7056	8056	9056	10056	11056	12056	##056
#/5V600	60.0	0.96	2060	3060	4060	5060	6060	7060	8060	9060	10060	11060	12060	##060
#/5V630	63.0	1.0	2063	3063	4063	5063	6063	7063	8063	9063	10063	11063	12063	##063
#/5V670	67.0	1.04	2067	3067	4067	5067	6067	7067	8067	9067	10067	11067	12067	##067
#/5V710	71.0	1.18	2071	3071	4071	5071	6071	7071	8071	9071	10071	11071	12071	##071
#/5V750	75.0	1.18	2075	3075	4075	5075	6075	7075	8075	9075	10075	11075	12075	##075
#/5V800	80.0	1.25	2080	3080	4080	5080	6080	7080	8080	9080	10080	11080	12080	##080
#/5V850	85.0	1.36	2085	3085	4085	5085	6085	7085	8085	9085	10085	11085	12085	##085

BANDA SUPER HC® POWERBAND®

SECCIÓN 5V

BANDA (#=UNIDAS)	LONG. EXT. (PULG.)	PESO/ BANDA (LBS.)	9386											13-30 BANDAS MAX.
			2 BDAS.	3 BDAS.	4 BDAS.	5 BDAS.	6 BDAS.	7 BDAS.	8 BDAS.	9 BDAS.	10 BDAS.	11 BDAS.	12 BDAS.	
#/5V900	90.0	1.39	2090	3090	4090	5090	6090	7090	8090	9090	10090	11090	12090	##090
#/5V950	95.0	1.50	2095	3095	4095	5095	6095	7095	8095	9095	10095	11095	12095	##095
#/5V1000	100.0	1.57	2100	3100	4100	5100	6100	7100	8100	9100	10100	11100	12100	##100
#/5V1060	106.0	1.71	2106	3106	4106	5106	6106	7106	8106	9106	10106	11106	12106	##106
#/5V1120	112.0	1.79	2112	3112	4112	5112	6112	7112	8112	9112	10112	11112	12112	##112
#/5V1180	118.0	1.86	2118	3118	4118	5118	6118	7118	8118	9118	10118	11118	12118	##118
#/5V1200	120.0	1.90	2120	3120	4120	5120	6120	7120	8120	9120	10120	11120	12120	##120
#/5V1210	121.0	1.92	2121	3121	4121	5121	6121	7121	8121	9121	10121	11121	12121	##121
#/5V1250	125.0	2.00	2125	3125	4125	5125	6125	7125	8125	9125	10125	11125	12125	##125
#/5V1320	132.0	2.11	2132	3132	4132	5132	6132	7132	8132	9132	10132	11132	12132	##132
#/5V1400	140.0	2.25	2140	3140	4140	5140	6140	7140	8140	9140	10140	11140	12140	##140
#/5V1500	150.0	2.39	2150	3150	4150	5150	6150	7150	8150	9150	10150	11150	12150	##150
#/5V1600	160.0	2.57	2160	3160	4160	5160	6160	7160	8160	9160	10160	11160	12160	##160
#/5V1700	170.0	2.75	2170	3170	4170	5170	6170	7170	8170	9170	10170	11170	12170	##170
#/5V1800	180.0	2.89	2180	3180	4180	5180	6180	7180	8180	9180	10180	11180	12180	##180
#/5V1900	190.0	3.07	2190	3190	4190	5190	6190	7190	8190	9190	10190	11190	12190	##190
#/5V2000	200.0	3.25	2200	3200	4200	5200	6200	7200	8200	9200	10200	11200	12200	##200
#/5V2120	212.0	3.46	2212	3212	4212	5212	6212	7212	8212	9212	10212	11212	12212	##212
#/5V2240	224.0	3.68	2224	3224	4224	5224	6224	7224	8224	9224	10224	11224	12224	##224
#/5V2360	236.0	3.89	2236	3236	4236	5236	6236	7236	8236	9236	10236	11236	12236	##236
#/5V2500	250.0	4.07	2250	3250	4250	5250	6250	7250	8250	9250	10250	11250	12250	##250
#/5V2650	265.0	4.32	2265	3265	4265	5265	6265	7265	8265	9265	10265	11265	12265	##265
#/5V2800	280.0	4.57	2280	3280	4280	5280	6280	7280	8280	9280	10280	11280	12280	##280
#/5V3000	300.0	4.89	2300	3300	4300	5300	6300	7300	8300	9300	10300	11300	12300	##300
#/5V3150	315.0	5.18	2315	3315	4315	5315	6315	7315	8315	9315	10315	11315	12315	##315
#/5V3350	335.0	5.50	2335	3335	4335	5335	6335	7335	8335	9335	10335	11335	12335	##335
#/5V3550	355.0	5.79	2355	3355	4355	5355	6355	7355	8355	9355	10355	11355	12355	##355



BANDA SUPER HC® POWERBAND®

SECCIÓN 8V

BANDA (#=UNIDAS)	LONG. EXT. (PULG.)	PESO/ BANDA (LBS.)	9385										
			2 BDAS.	3 BDAS.	4 BDAS.	5 BDAS.	6 BDAS.	7 BDAS.	8 BDAS.	9 BDAS.	10 BDAS.	11 BDAS.	12 BDAS.
#/8V1000	100.0	3.90	2100	3100	4100	5100	6100	7100	8100	9100	10100	11100	12100
#/8V1060	106.0	4.15	2106	3106	4106	5106	6106	7106	8106	9106	10106	11106	12106
#/8V1120	112.0	4.42	2112	3112	4112	5112	6112	7112	8112	9112	10112	11112	12112
#/8V1180	118.0	4.67	2118	3118	4118	5118	6118	7118	8118	9118	10118	11118	12118
#/8V1250	125.0	5.00	2125	3125	4125	5125	6125	7125	8125	9125	10125	11125	12125
#/8V1320	132.0	5.25	2132	3132	4132	5132	6132	7132	8132	9132	10132	11132	12132
#/8V1400	140.0	5.58	2140	3140	4140	5140	6140	7140	8140	9140	10140	11140	12140

BANDA SUPER HC® POWERBAND®**SECCIÓN 8V**

BANDA (#=UNIDAS)	LONG. EXT. (PULG.)	PESO/ BANDA (LBS.)	9385										
			2 BDAS.	3 BDAS.	4 BDAS.	5 BDAS.	6 BDAS.	7 BDAS.	8 BDAS.	9 BDAS.	10 BDAS.	11 BDAS.	12 BDAS.
#/8V1500	150.0	6.00	2150	3150	4150	5150	6150	7150	8150	9150	10150	11150	12150
#/8V1600	160.0	6.33	2160	3160	4160	5160	6160	7160	8160	9160	10160	11160	12160
#/8V1700	170.0	6.75	2170	3170	4170	5170	6170	7170	8170	9170	10170	11170	12170
#/8V1800	180.0	7.25	2180	3180	4180	5180	6180	7180	8180	9180	10180	11180	12180
#/8V1900	190.0	7.67	2190	3190	4190	5190	6190	7190	8190	9190	10190	11190	12190
#/8V2000	200.0	8.00	2200	3200	4200	5200	6200	7200	8200	9200	10200	11200	12200
#/8V2120	212.0	8.50	2212	3212	4212	5212	6212	7212	8212	9212	10212	11212	12212
#/8V2240	224.0	9.00	2224	3224	4224	5224	6224	7224	8224	9224	10224	11224	12224
#/8V2360	236.0	9.42	2236	3236	4236	5236	6236	7236	8236	9236	10236	11236	12236
#/8V2500	250.0	10.0	2250	3250	4250	5250	6250	7250	8250	9250	10250	11250	12250
#/8V2650	265.0	10.5	2265	3265	4265	5265	6265	7265	8265	9265	10265	11265	12265
#/8V2800	280.0	11.3	2280	3280	4280	5280	6280	7280	8280	9280	10280	11280	12280
#/8V3000	300.0	12.0	2300	3300	4300	5300	6300	7300	8300	9300	10300	11300	12300
#/8V3150	315.0	12.7	2315	3315	4315	5315	6315	7315	8315	9315	10315	11315	12315
#/8V3350	335.0	13.5	2335	3335	4335	5335	6335	7335	8335	9335	10335	11335	12335
#/8V3550	355.0	14.3	2355	3355	4355	5355	6355	7355	8355	9355	10355	11355	12355
#/8V3750	375.0	15.0	2375	3375	4375	5375	6375	7375	8375	9375	10375	11375	12375
#/8V4000	400.0	16.0	2400	3400	4400	5400	6400	7400	8400	9400	10400	11400	12400
#/8V4250	425.0	17.0	2425	3425	4425	5425	6425	7425	8425	9425	10425	11425	12425
#/8V4500	450.0	18.0	2450	3450	4450	5450	6450	7450	8450	9450	10450	11450	12450
#/8V4750	475.0	19.1	2475	3475	4475	5475	6475	7475	8475	9475	10475	11475	12475
#/8V5000	500.0	20.1	2500	3500	4500	5500	6500	7500	8500	9500	10500	11500	12500
#/8V5600	560.0	22.7	2560	3560	4560	5560	6560	7560	8560	9560	10560	11560	12560
#/8V6000	600.0	24.4	2600	3600	4600	5600	6600	7600	8600	9600	10600	11600	12600

BANDAS SUPER HC®

DENTADA MOLDEADA POWERBAND®

Las bandas Power Band® logran que varias bandas funcionen como una sola, con igual distribución de carga y cada una de ellas.

MERCADOS/APLICACIONES

Recomendadas para usos múltiples en transmisiones de bandas en V expuestas a vibración o fuertes cargas de choque, o bien que se pudieran voltear o brincar fuera de la transmisión.

CARACTERÍSTICAS/VENTAJAS

- La cubierta de la banda asegura alta rigidez lateral, guiando a la banda en una línea recta y previniéndola de que salte de la transmisión.
- El Dentado moldeado especial de la banda es la mejor opción para transmisiones con diámetros de poleas pequeñas.
- Sus Cuerdas Flex-Bonded® están fuertemente unidas al cuerpo de la banda, con carga uniforme y la absorción de la fuerza de compresión a causa de poleas de diámetros pequeños sin que se deteriore la cuerda.
- Satisface los estándares de resistencia al petróleo y calor.
- Satisface los requerimientos RMA de conductividad estática.

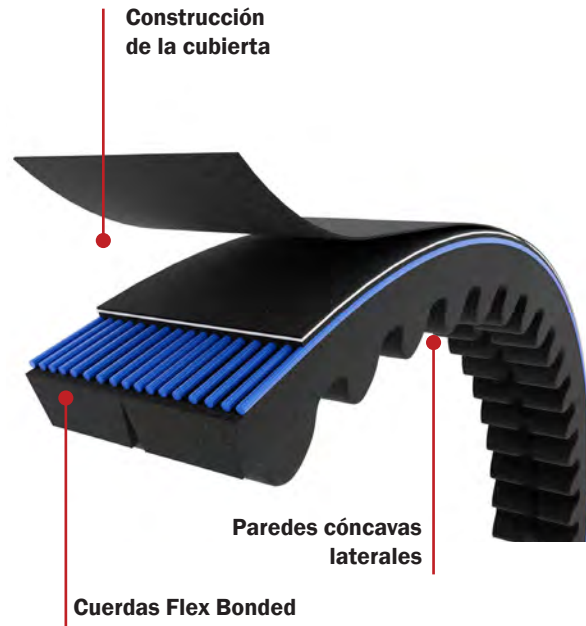

Poleas recomendadas: Poleas Super HC®

Notas: Orden con cantidad mínima no es requerida en longitudes listadas.

Las bandas Super HC® Power Band® con seis bandas unidas o más puede requerir tiempo de entrega

El número de parte es constituido colocando el número de bandas unidas seguidas por una diagonal (/), además de la sección y tamaño de la banda. Por ejemplo 5/5VX1400 representa 5 bandas unidas de la banda 5VX1400.



BANDA SUPER HC® DENTADA MOLDEADA POWERBAND®

SECCIÓN 3VX

BANDA (#=UNIDAS)	LONG. EXT. (PULG.)	PESO/BANDA (LBS.)	9388												13-22 BANDAS MAX.
			2 BDAS.	3 BDAS.	4 BDAS.	5 BDAS.	6 BDAS.	7 BDAS.	8 BDAS.	9 BDAS.	10 BDAS.	11 BDAS.	12 BDAS.		
#/3VX250	25.0	0.10	2025	3025	4025	5025									
#/3VX265	26.5	0.14	2026	3026	4026	5026									
#/3VX280	28.0	0.16	2028	3028	4028	5028									
#/3VX300	30.0	0.18	2030	3030	4030	5030	6030	7030	8030	9030	10030	11030	12030	##030	
#/3VX315	31.5	0.20	2031	3031	4031	5031	6031	7031	8031	9031	10031	11031	12031	##031	
#/3VX335	33.5	0.20	2033	3033	4033	5033	6033	7033	8033	9033	10033	11033	12033	##033	
#/3VX355	35.5	0.20	2035	3035	4035	5035	6035	7035	8035	9035	10035	11035	12035	##035	

BANDA SUPER HC® DENTADA MOLDEADA POWERBAND®**SECCIÓN 3VX**

BANDA (#=UNIDAS)	LONG. EXT. (PULG.)	PESO/ BANDA (LBS.)	9388											13-22 BANDAS MAX.
			2 BDAS.	3 BDAS.	4 BDAS.	5 BDAS.	6 BDAS.	7 BDAS.	8 BDAS.	9 BDAS.	10 BDAS.	11 BDAS.	12 BDAS.	
#/3VX375	37.5	0.22	2037	3037	4037	5037	6037	7037	8037	9037	10037	11037	12037	##037
#/3VX400	40.0	0.24	2040	3040	4040	5040	6040	7040	8040	9040	10040	11040	12040	##040
#/3VX425	42.5	0.26	2042	3042	4042	5042	6042	7042	8042	9042	10042	11042	12042	##042
#/3VX450	45.0	0.28	2045	3045	4045	5045	6045	7045	8045	9045	10045	11045	12045	##045
#/3VX475	47.5	0.29	2047	3047	4047	5047	6047	7047	8047	9047	10047	11047	12047	##047
#/3VX500	50.0	0.30	2050	3050	4050	5050	6050	7050	8050	9050	10050	11050	12050	##050
#/3VX530	53.0	0.33	2053	3053	4053	5053	6053	7053	8053	9053	10053	11053	12053	##053
#/3VX560	56.0	0.34	2056	3056	4056	5056	6056	7056	8056	9056	10056	11056	12056	##056
#/3VX600	60.0	0.37	2060	3060	4060	5060	6060	7060	8060	9060	10060	11060	12060	##060
#/3VX630	63.0	0.40	2063	3063	4063	5063	6063	7063	8063	9063	10063	11063	12063	##063
#/3VX670	67.0	0.41	2067	3067	4067	5067	6067	7067	8067	9067	10067	11067	12067	##067
#/3VX710	71.0	0.44	2071	3071	4071	5071	6071	7071	8071	9071	10071	11071	12071	##071
#/3VX750	75.0	0.46	2075	3075	4075	5075	6075	7075	8075	9075	10075	11075	12075	##075
#/3VX800	80.0	0.50	2080	3080	4080	5080	6080	7080	8080	9080	10080	11080	12080	##080
#/3VX850	85.0	0.53	2085	3085	4085	5085	6085	7085	8085	9085	10085	11085	12085	##085
#/3VX900	90.0	0.56	2090	3090	4090	5090	6090	7090	8090	9090	10090	11090	12090	##090
#/3VX950	95.0	0.60	2095	3095	4095	5095	6095	7095	8095	9095	10095	11095	12095	##095
#/3VX1000	100.0	0.63	2100	3100	4100	5100	6100	7100	8100	9100	10100	11100	12100	##100
#/3VX1060	106.0	0.66	2106	3106	4106	5106	6106	7106	8106	9106	10106	11106	12106	##106
#/3VX1120	112.0	0.70	2112	3112	4112	5112	6112	7112	8112	9112	10112	11112	12112	##112
#/3VX1180	118.0	0.74	2118	3118	4118	5118	6118	7118	8118	9118	10118	11118	12118	##118
#/3VX1250	125.0	0.79	2125	3125	4125	5125	6125	7125	8125	9125	10125	11125	12125	##125
#/3VX1320	132.0	0.83	2132	3132	4132	5132	6132	7132	8132	9132	10132	11132	12132	##132
#/3VX1400	140.0	0.88	2140	3140	4140	5140	6140	7140	8140	9140	10140	11140	12140	##140

**BANDA SUPER HC® DENTADA MOLDEADA POWERBAND®****SECCIÓN 5VX**

BANDA (#=UNIDAS)	LONG. EXT. (PULG.)	PESO/ BANDA (LBS.)	9389										13 BDAS.	
			2 BDAS.	3 BDAS.	4 BDAS.	5 BDAS.	6 BDAS.	7 BDAS.	8 BDAS.	9 BDAS.	10 BDAS.	11 BDAS.		12 BDAS.
#/5VX500	50.0	0.70	2050	3050	4050	5050	6050	7050	8050	9050	10050	11050	12050	13050
#/5VX530	53.0	0.80	2053	3053	4053	5053	6053	7053	8053	9053	10053	11053	12053	13053
#/5VX560	56.0	0.86	2056	3056	4056	5056	6056	7056	8056	9056	10056	11056	12056	13056
#/5VX600	60.0	0.96	2060	3060	4060	5060	6060	7060	8060	9060	10060	11060	12060	13060
#/5VX630	63.0	1.00	2063	3063	4063	5063	6063	7063	8063	9063	10063	11063	12063	13063
#/5VX670	67.0	1.04	2067	3067	4067	5067	6067	7067	8067	9067	10067	11067	12067	13067
#/5VX710	71.0	1.18	2071	3071	4071	5071	6071	7071	8071	9071	10071	11071	12071	13071
#/5VX750	75.0	1.21	2075	3075	4075	5075	6075	7075	8075	9075	10075	11075	12075	13075

BANDA SUPER HC® DENTADA MOLDEADA POWERBAND®**SECCIÓN 5VX**

BANDA (#=UNIDAS)	LONG. EXT. (PULG.)	PESO/ BANDA (LBS.)	9389											
			2 BDAS.	3 BDAS.	4 BDAS.	5 BDAS.	6 BDAS.	7 BDAS.	8 BDAS.	9 BDAS.	10 BDAS.	11 BDAS.	12 BDAS.	13 BDAS.
#/5VX800	80.0	1.25	2080	3080	4080	5080	6080	7080	8080	9080	10080	11080	12080	13080
#/5VX850	85.0	1.36	2085	3085	4085	5085	6085	7085	8085	9085	10085	11085	12085	13085
#/5VX900	90.0	1.39	2090	3090	4090	5090	6090	7090	8090	9090	10090	11090	12090	13090
#/5VX950	95.0	1.50	2095	3095	4095	5095	6095	7095	8095	9095	10095	11095	12095	13095
#/5VX1000	100.0	1.57	2100	3100	4100	5100	6100	7100	8100	9100	10100	11100	12100	13100
#/5VX1060	106.0	1.71	2106	3106	4106	5106	6106	7106	8106	9106	10106	11106	12106	13106
#/5VX1120	112.0	1.79	2112	3112	4112	5112	6112	7112	8112	9112	10112	11112	12112	13112
#/5VX1180	118.0	1.86	2118	3118	4118	5118	6118	7118	8118	9118	10118	11118	12118	13118
#/5VX1250	125.0	2.00	2125	3125	4125	5125	6125	7125	8125	9125	10125	11125	12125	13125
#/5VX1320	132.0	2.11	2132	3132	4132	5132	6132	7132	8132	9132	10132	11132	12132	13132
#/5VX1400	140.0	2.25	2140	3140	4140	5140	6140	7140	8140	9140	10140	11140	12140	13140
#/5VX1500	150.0	2.39	2150	3150	4150	5150	6150	7150	8150	9150	10150	11150	12150	13150
#/5VX1600	160.0	2.57	2160	3160	4160	5160	6160	7160	8160	9160	10160	11160	12160	13160
#/5VX1700	170.0	2.75	2170	3170	4170	5170	6170	7170	8170	9170	10170	11170	12170	13170
#/5VX1800	180.0	2.89	2180	3180	4180	5180	6180	7180	8180	9180	10180	11180	12180	13180
#/5VX1900	190.0	3.07	2190	3190	4190	5190	6190	7190	8190	9190	10190	11190	12190	13190
#/5VX2000	200.0	3.25	2200	3200	4200	5200	6200	7200	8200	9200	10200	11200	12200	13200

BANDAS PREDATOR®

Específicamente diseñada para aplicaciones con muy alta carga. Su novedosa construcción para servicio pesado proporciona extraordinaria resistencia a los altos impactos, gran potencia, capacidad y tenacidad durante su uso.

MERCADOS/APLICACIONES

Las bandas Predator® son convenientes como bandas de reemplazo para aplicaciones expuestas a vibraciones o cargas de choque. Son muy utilizadas en la Industria minera, agricultura, procesamiento de madera, equipos en campos petroleros, construcciones y operaciones con grava y arena.

CARACTERÍSTICAS/VENTAJAS

- La cuerda tensora de aramida ofrece alta resistencia a la elongación con una extraordinaria capacidad de cargas y durabilidad.
- La cubierta de la banda soporta y la protege de impurezas, lo que le permite deslizarse aún en condiciones extremas de carga de choque; reduce la generación de calor y prolonga su vida útil.
- Satisface los estándares RMA de resistencia al petróleo y al calor.
- Sus curvas proporcionan a las cuerdas máximo contacto con la ranura de la polea, con carga uniforme y prolongada vida útil.

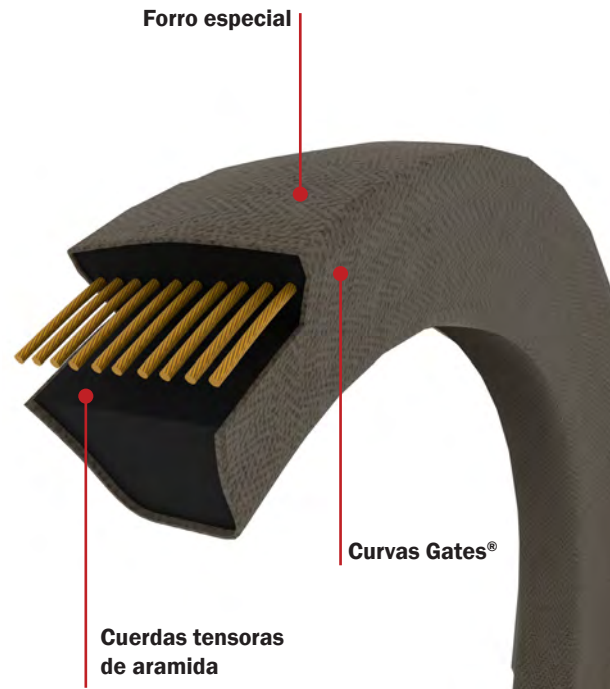

Notas: Orden con cantidad mínima no es requerida en longitudes listadas. Verifique disponibilidad con Servicio a Clientes. Las bandas Predator® listadas pueden requerir tiempos de entrega de manufactura. Las bandas Predator® no satisfacen requerimientos RMA para bandas de conductividad estática.



BANDA PREDATOR®

SECCIÓN AP

DESCRIPCIÓN	CÓDIGO	LONG. (PULG.)	PESO (LBS.)	DESCRIPCIÓN	CÓDIGO	LONG. (PULG.)	PESO (LBS.)
AP31	91850031	33	0.24	AP48	91850048	50	0.37
AP33	91850033	35	0.26	AP50	91850050	52	0.38
AP35	91850035	37	0.27	AP51	91850051	53	0.39
AP38	91850038	40	0.29	AP52	91850052	54	0.4
AP40	91850040	42	0.31	AP53	91850053	55	0.4
AP42	91850042	44	0.32	AP54	91850054	56	0.41
AP43	91850043	45	0.33	AP55	91850055	57	0.42
AP44	91850044	46	0.34	AP56	91850056	58	0.43
AP45	91850045	47	0.35	AP58	91850058	60	0.44
AP46	91850046	48	0.35	AP59	91850059	61	0.45
AP47	91850047	49	0.36	AP60	91850060	62	0.46

BANDA PREDATOR®**SECCIÓN AP**

DESCRIPCIÓN	CÓDIGO	LONG. (PULG.)	PESO (LBS.)	DESCRIPCIÓN	CÓDIGO	LONG. (PULG.)	PESO (LBS.)
AP61	91850061	63	0.46	AP70	91850070	72	0.53
AP62	91850062	64	0.47	AP71	91850071	73	0.54
AP63	91850063	65	0.48	AP85	91850085	87	0.64
AP64	91850064	66	0.48	AP87	91850087	89	0.65
AP66	91850066	68	0.5	AP90	91850090	92	0.68
AP68	91850068	70	0.51	AP91	91850091	93	0.69

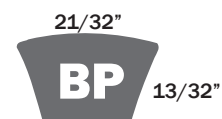
**BANDA PREDATOR®****SECCIÓN BP**

DESCRIPCIÓN	CÓDIGO	LONG. (PULG.)	PESO (LBS.)	DESCRIPCIÓN	CÓDIGO	LONG. (PULG.)	PESO (LBS.)
BP32	91860032	35	0.39	BP70	91860070	73	0.82
BP38	91860038	41	0.46	BP71	91860071	74	0.83
BP40	91860040	43	0.48	BP75	91860075	78	0.87
BP42	91860042	45	0.5	BP78	91860078	81	0.91
BP44	91860044	47	0.53	BP80	91860080	83	0.93
BP46	91860046	49	0.55	BP81	91860081	84	0.94
BP48	91860048	51	0.57	BP83	91860083	86	0.96
BP50	91860050	53	0.59	BP85	91860085	88	0.99
BP51	91860051	54	0.61	BP90	91860090	93	1.04
BP52	91860052	55	0.62	BP93	91860093	96	1.08
BP53	91860053	56	0.63	BP95	91860095	98	1.1
BP54	91860054	57	0.64	BP97	91860097	100	1.12
BP55	91860055	58	0.65	BP100	91860100	103	1.15
BP56	91860056	59	0.66	BP103	91860103	106	1.19
BP57	91860057	60	0.67	BP105	91860105	108	1.21
BP58	91860058	61	0.68	BP108	91860108	111	1.24
BP59	91860059	62	0.69	BP112	91860112	115	1.29
BP60	91860060	63	0.71	BP120	91860120	123	1.38
BP61	91860061	64	0.72	BP124	91860124	127	1.42
BP62	91860062	65	0.73	BP128	91860128	131	1.47
BP63	91860063	66	0.74	BP136	91860136	139	1.56
BP64	91860064	67	0.75	BP144	91860144	147	1.65
BP65	91860065	68	0.76	BP158	91860158	161	1.8
BP66	91860066	69	0.77	BP173	91860173	176	1.97
BP68	91860068	71	0.8	BP195	91860195	198	2.22

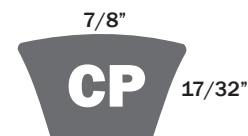
**BANDA PREDATOR®****SECCIÓN CP**

DESCRIPCIÓN	CÓDIGO	LONG. (PULG.)	PESO (LBS.)
CP85	91870085	89	1.86
CP90	91870090	94	1.96
CP96	91870096	100	2.09
CP99	91870099	103	2.15
CP100	91870100	104	2.17
CP105	91870105	109	2.27
CP112	91870112	116	2.42
CP120	91870120	124	2.59
CP128	91870128	132	2.75

DESCRIPCIÓN	CÓDIGO	LONG. (PULG.)	PESO (LBS.)
CP136	91870136	140	2.92
CP144	91870144	148	3.09
CP158	91870158	162	3.38
CP162	91870162	166	3.46
CP173	91870173	177	3.69
CP180	91870180	184	3.84
CP195	91870195	199	4.15
CP240	91870240	242	5.05

**BANDA PREDATOR®****SECCIÓN 5VP**

DESCRIPCIÓN	CÓDIGO	LONG. (PULG.)	PESO (LBS.)
5VP800	91880080	80	1.02
5VP850	91880085	85	1.08
5VP900	91880090	90	1.15
5VP950	91880095	95	1.21
5VP1000	91880100	100	1.28
5VP1060	91880106	106	1.35
5VP1120	91880112	112	1.43
5VP1180	91880118	118	1.5
5VP1250	91880125	125	1.59
5VP1320	91880132	132	1.68
5VP1400	91880140	140	1.79
5VP1500	91880150	150	1.91
5VP1600	91880160	160	2.04
5VP1700	91880170	170	2.17

DESCRIPCIÓN	CÓDIGO	LONG. (PULG.)	PESO (LBS.)
5VP1800	91880180	180	2.3
5VP1900	91880190	190	2.42
5VP2000	91880200	200	2.55
5VP2120	91880212	212	2.7
5VP2240	91880224	224	2.86
5VP2360	91880236	236	3.01
5VP2500	91880250	250	3.19
5VP2650	91880265	265	3.38
5VP2800	91880280	280	3.57
5VP3000	91880300	300	3.83
5VP3150	91880315	315	4.02
5VP3350	91880335	335	4.27
5VP3550	91880355	355	4.53

**BANDA PREDATOR®****SECCIÓN 8VP**

DESCRIPCIÓN	CÓDIGO	LONG. (PULG.)	PESO (LBS.)	DESCRIPCIÓN	CÓDIGO	LONG. (PULG.)	PESO (LBS.)
8VP1600	91890160	160	5.29	8VP2500	91890250	250	8.26
8VP1700	91890170	170	7	8VP2650	91890265	265	8.75
8VP1800	91890180	180	5.95	8VP2800	91890280	280	9.25
8VP1900	91890190	190	6.28	8VP3000	91890300	300	9.91
8VP2000	91890200	200	6.61	8VP3150	91890315	315	11.1
8VP2120	91890212	212	7	8VP3350	91890335	335	11.07
8VP2240	91890224	224	7.4	8VP3550	91890355	355	11.73
8VP2360	91890236	236	7.8				

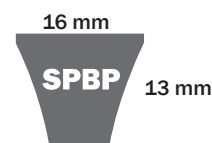
**BANDA PREDATOR®****SECCIÓN SPBP**

DESCRIPCIÓN	CÓDIGO	LONG. (PULG.)	PESO (LBS.)	DESCRIPCIÓN	CÓDIGO	LONG. (PULG.)	PESO (LBS.)
SPB1260P	919001260	1260	0.66	SPB3550P	919003550	3550	1.87
SPB1500P	919001500	1500	0.79	SPB3750P	919003750	3750	1.98
SPB1600P	919001600	1600	0.84	SPB4000P	919004000	4000	2.11
SPB1700P	919001700	1700	0.9	SPB4250P	919004250	4250	2.24
SPB1800P	919001800	1800	0.95	SPB4500P	919004500	4500	2.37
SPB1900P	919001900	1900	1	SPB4750P	919004750	4750	2.5
SPB2000P	919002000	2000	1.05	SPB5000P	919005000	5000	2.64
SPB2120P	919002120	2120	1.12	SPB5300P	919005300	5300	2.79
SPB2240P	919002240	2240	1.18	SPB5600P	919005600	5600	2.95
SPB2360P	919002360	2360	1.24	SPB6000P	919006000	6000	3.16
SPB2500P	919002500	2500	1.32	SPB6300P	919006300	6300	3.32
SPB2650P	919002650	2650	1.4	SPB6700P	919006700	6700	3.53
SPB2800P	919002800	2800	1.48	SPB7100P	919007100	7100	3.74
SPB3000P	919003000	3000	1.58	SPB7500P	919007500	7500	3.96
SPB3150P	919003150	3150	1.66	SPB8000P	919008000	8000	4.22
SPB3350P	919003350	3350	1.77				

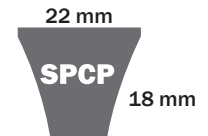
**BANDA PREDATOR®****SECCIÓN SPCP**

DESCRIPCIÓN	CÓDIGO	LONG. (PULG.)	PESO (LBS.)	DESCRIPCIÓN	CÓDIGO	LONG. (PULG.)	PESO (LBS.)
SPC2000P	919102000	2000	1.91	SPC4500P	919104500	4500	4.3
SPC2120P	919102120	2120	2.03	SPC4750P	919104750	4750	4.54
SPC2240P	919102240	2240	2.14	SPC5000P	919105000	5000	4.78
SPC2360P	919102360	2360	2.26	SPC5300P	919105300	5300	5.07
SPC2500P	919102500	2500	2.39	SPC5600P	919105600	5600	5.35
SPC2650P	919102650	2650	2.53	SPC6000P	919106000	6000	5.73
SPC2800P	919102800	2800	2.68	SPC6300P	919106300	6300	6.02
SPC3000P	919103000	3000	2.87	SPC6700P	919106700	6700	6.4
SPC3150P	919103150	3150	3.01	SPC7100P	919107100	7100	6.79
SPC3350P	919103350	3350	3.2	SPC7500P	919107500	7500	7.17
SPC3550P	919103550	3550	3.39	SPC8000P	919108000	8000	7.65
SPC3750P	919103750	3750	3.58	SPC8500P	919108500	8500	8.12
SPC4000P	919104000	4000	3.82	SPC9000P	919109000	9000	8.6
SPC4250P	919104250	4250	4.06				

BANDAS PREDATOR®

POWERBAND®

Específicamente diseñado para aplicaciones sumamente demandantes, esta banda de construcción de servicio pesado proporciona extraordinario rendimiento y resistencia excepcional a las cargas de choque, capacidad y resistencia al desgaste.

MERCADOS/APLICACIONES

Las bandas Predator® son la mejor opción para aplicaciones expuestas a vibraciones o fuertes cargas de choque, tal como sucede en la Industria minera, agricultura, procesamiento de madera, campos de petroleros, construcción y operaciones de grava y arena.

CARACTERÍSTICAS/VENTAJAS

- La cuerda tensora de aramida ofrece alta resistencia a la elongación con una extraordinaria capacidad de cargas y durabilidad.
- La cubierta de la banda soporta y la protege de impurezas, lo que le permite deslizarse aún en condiciones extremas de carga de choque; reduce la generación de calor y prolonga su vida útil.
- Satisface los estándares RMA de resistencia a los aceites y al calor.
- Sus curvas proporcionan a las cuerdas máximo contacto con la ranura de la polea, con carga uniforme y prolongada vida útil.

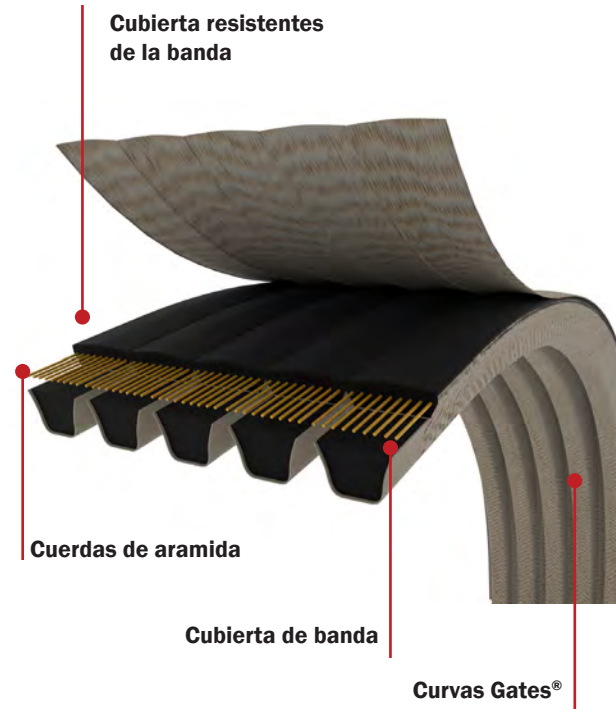

Poleas recomendadas: Contacta al equipo de Gates de órdenes de producción de metales.

Notas: Orden con cantidad mínima no es requerida en longitudes listadas. Verifique disponibilidad con Servicio a Clientes. Las bandas Predator® pueden requerir tiempos de entrega de manufactura. Cuando la aplicación requiere set de banda Predator®, solicite bandas del mismo grupo/número. Las bandas Predator no satisfacen los requerimientos RMA para bandas de conductividad estática. La nomenclatura indica el número de bandas unidas con el signo #requeridas, seguido por una diagonal (/) y el número de la banda. Por ejemplo 5/8VP3000 representa 5 bandas unidas de la 8VP3000.



BANDA PREDATOR® POWERBAND®

SECCIÓN CP

DESCRIPCIÓN	CÓDIGO	LONG. (PULG.)	PESO (LBS.)	DESCRIPCIÓN	CÓDIGO	LONG. (PULG.)	PESO (LBS.)
3/CP85	91843085	89	6.78	4/CP345	91844345	347	30.39
3/CP90	91843090	94	7.11	4/CP360	91844360	362	31.7
3/CP99	91843099	103	8.1	5/CP195	91845195	199	21.79
3/CP240	91844240	242	21.19	5/CP195	91845225	227	24.85
3/CP330	91844330	332	29.08	5/CP225	91845225	257	28.13

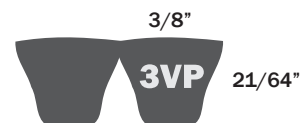
**BANDA PREDATOR® POWERBAND®****SECCIÓN 3VP**

BANDA (#=UNIDAS)	LONG. EXT. (PULG.)	PESO/BANDA (LBS.)	9389									
			2 BDAS.	3 BDAS.	4 BDAS.	5 BDAS.	6 BDAS.	7 BDAS.	8 BDAS.	9 BDAS.	10 BDAS.	
#/3VP450	45.0	0.28	2045	3045	4045	5045	6045	7045	8045	9045	10045	
#/3VP475	47.5	0.29	2047	3047	4047	5047	6047	7047	8047	9047	10047	
#/3VP500	50.0	0.30	2050	3050	4050	5050	6050	7050	8050	9050	10050	
#/3VP530	53.0	0.33	2053	3053	4053	5053	6053	7053	8053	9053	10053	
#/3VP560	56.0	0.34	2056	3056	4056	5056	6056	7056	8056	9056	10056	
#/3VP600	60.0	0.37	2060	3060	4060	5060	6060	7060	8060	9060	10060	
#/3VP630	63.0	0.40	2063	3063	4063	5063	6063	7063	8063	9063	10063	
#/3VP670	67.0	0.41	2067	3067	4067	5067	6067	7067	8067	9067	10067	
#/3VP710	71.0	0.44	2071	3071	4071	5071	6071	7071	8071	9071	10071	
#/3VP750	75.0	0.46	2075	3075	4075	5075	6075	7075	8075	9075	10075	
#/3VP800	80.0	0.50	2080	3080	4080	5080	6080	7080	8080	9080	10080	
#/3VP850	85.0	0.53	2085	3085	4085	5085	6085	7085	8085	9085	10085	
#/3VP900	90.0	0.56	2090	3090	4090	5090	6090	7090	8090	9090	10090	
#/3VP950	95.0	0.60	2095	3095	4095	5095	6095	7095	8095	9095	10095	
#/3VP1000	100.0	0.63	2100	3100	4100	5100	6100	7100	8100	9100	10100	
#/3VP1060	106.0	0.66	2106	3106	4106	5106	6106	7106	8106	9106	10106	
#/3VP1120	112.0	0.70	2112	3112	4112	5112	6112	7112	8112	9112	10112	
#/3VP1180	118.0	0.74	2118	3118	4118	5118	6118	7118	8118	9118	10118	
#/3VP1250	125.0	0.79	2125	3125	4125	5125	6125	7125	8125	9125	10125	
#/3VP1320	132.0	0.83	2132	3132	4132	5132	6132	7132	8132	9132	10132	
#/3VP1400	140.0	0.88	2140	3140	4140	5140	6140	7140	8140	9140	10140	

**BANDA PREDATOR® POWERBAND®****SECCIÓN 5VP**

BANDA (#=UNIDAS)	LONG. EXT. (PULG.)	PESO/ BANDA (LBS.)	9181											13-16 BANDAS MÁX.
			2 BDAS.	3 BDAS.	4 BDAS.	5 BDAS.	6 BDAS.	7 BDAS.	8 BDAS.	9 BDAS.	10 BDAS.	11 BDAS.	12 BDAS.	
#/5VP600	60.0	0.96	2060	3060	4060	5060	6060	7060	8060	9060	10060	11060	12060	##060
#/5VP630	63.0	1.00	2063	3063	4063	5063	6063	7063	8063	9063	10063	11063	12063	##063
#/5VP670	67.0	1.04	2067	3067	4067	5067	6067	7067	8067	9067	10067	11067	12067	##067
#/5VP710	71.0	1.18	2071	3071	4071	5071	6071	7071	8071	9071	10071	11071	12071	##071
#/5VP730	73.0	1.20	2073	3073	4073	5073	6073	7073	8073	9073	10073	11073	12073	##073
#/5VP750	75.0	1.21	2075	3075	4075	5075	6075	7075	8075	9075	10075	11075	12075	##075
#/5VP800	80.0	1.25	2080	3080	4080	5080	6080	7080	8080	9080	10080	11080	12080	##080

BANDA PREDATOR® POWERBAND®

SECCIÓN 5VP

BANDA (#=UNIDAS)	LONG. EXT. (PULG.)	PESO/ BANDA (LBS.)	9181											13-16 BANDAS MAX.
			2 BDAS.	3 BDAS.	4 BDAS.	5 BDAS.	6 BDAS.	7 BDAS.	8 BDAS.	9 BDAS.	10 BDAS.	11 BDAS.	12 BDAS.	
#/5VP850	85.0	1.36	2085	3085	4085	5085	6085	7085	8085	9085	10085	11085	12085	##085
#/5VP870	87.0	1.40	2087	3087	4087	5087	6087	7087	8087	9087	10087	11087	12087	##087
#/5VP900	90.0	1.39	2090	3090	4090	5090	6090	7090	8090	9090	10090	11090	12090	##090
#/5VP950	95.0	1.50	2095	3095	4095	5095	6095	7095	8095	9095	10095	11095	12095	##095
#/5VP1000	100.0	1.57	2100	3100	4100	5100	6100	7100	8100	9100	10100	11100	12100	##100
#/5VP1060	106.0	1.25	2106	3106	4106	5106	6106	7106	8106	9106	10106	11106	12106	##106
#/5VP1120	112.0	1.79	2112	3112	4112	5112	6112	7112	8112	9112	10112	11112	12112	##112
#/5VP1180	118.0	1.86	2118	3118	4118	5118	6118	7118	8118	9118	10118	11118	12118	##118
#/5VP1250	125.0	2.00	2125	3125	4125	5125	6125	7125	8125	9125	10125	11125	12125	##125
#/5VP1320	132.0	2.11	2132	3132	4132	5132	6132	7132	8132	9132	10132	11132	12132	##132
#/5VP1400	140.0	2.25	2140	3140	4140	5140	6140	7140	8140	9140	10140	11140	12140	##140
#/5VP1500	150.0	2.39	2150	3150	4150	5150	6150	7150	8150	9150	10150	11150	12150	##150
#/5VP1600	160.0	2.57	2160	3160	4160	5160	6160	7160	8160	9160	10160	11160	12160	##160
#/5VP1700	170.0	2.75	2170	3170	4170	5170	6170	7170	8170	9170	10170	11170	12170	##170
#/5VP1800	180.0	2.89	2180	3180	4180	5180	6180	7180	8180	9180	10180	11180	12180	##180
#/5VP1900	190.0	3.07	2190	3190	4190	5190	6190	7190	8190	9190	10190	11190	12190	##190
#/5VP2000	200.0	3.25	2200	3200	4200	5200	6200	7200	8200	9200	10200	11200	12200	##200
#/5VP2030	203.0	3.30	2203	3203	4203	5203	6203	7203	8203	9203	10203	11203	12203	##203
#/5VP2120	212.0	3.46	2212	3212	4212	5212	6212	7212	8212	9212	10212	11212	12212	##212
#/5VP2240	224.0	3.68	2224	3224	4224	5224	6224	7224	8224	9224	10224	11224	12224	##224
#/5VP2360	236.0	3.89	2236	3236	4236	5236	6236	7236	8236	9236	10236	11236	12236	##236
#/5VP2500	250.0	4.07	2250	3250	4250	5250	6250	7250	8250	9250	10250	11250	12250	##250
#/5VP2650	265.0	4.32	2265	3265	4265	5265	6265	7265	8265	9265	10265	11265	12265	##265
#/5VP2800	280.0	4.57	2280	3280	4280	5280	6280	7280	8280	9280	10280	11280	12280	##280
#/5VP3000	300.0	4.89	2300	3300	4300	5300	6300	7300	8300	9300	10300	11300	12300	##300
#/5VP3150	315.0	5.18	2315	3315	4315	5315	6315	7315	8315	9315	10315	11315	12315	##315
#/5VP3350	335.0	5.50	2335	3335	4335	5335	6335	7335	8335	9335	10335	11335	12335	##335



BANDA PREDATOR® POWERBAND®

SECCIÓN 8VP

BANDA (#=UNIDAS)	LONG. EXT. (PULG.)	PESO/ BANDA (LBS.)	9182										
			2 BDAS.	3 BDAS.	4 BDAS.	5 BDAS.	6 BDAS.	7 BDAS.	8 BDAS.	9 BDAS.	10 BDAS.	11 BDAS.	12 BDAS.
#/8VP1000	100.0	3.90	2100	3100	4100	5100	6100	7100	8100	9100	10100	11100	12100
#/8VP1060	106.0	4.15	2106	3106	4106	5106	6106	7106	8106	9106	10106	11106	12106
#/8VP1120	112.0	4.42	2112	3112	4112	5112	6112	7112	8112	9112	10112	11112	12112
#/8VP1180	118.0	4.67	2118	3118	4118	5118	6118	7118	8118	9118	10118	11118	12118
#/8VP1250	125.0	5.00	2125	3125	4125	5125	6125	7125	8125	9125	10125	11125	12125

BANDAS PREDATOR® POWERBAND®

BANDA PREDATOR® POWER BAND®**SECCIÓN 8VP**

BANDA (#=UNIDAS)	LONG. EXT. (PULG.)	PESO/ BANDA (LBS.)	9182										
			2 BDAS.	3 BDAS.	4 BDAS.	5 BDAS.	6 BDAS.	7 BDAS.	8 BDAS.	9 BDAS.	10 BDAS.	11 BDAS.	12 BDAS.
#/8VP1320	132.0	5.25	2132	3132	4132	5132	6132	7132	8132	9132	10132	11132	12132
#/8VP1400	140.0	5.58	2140	3140	4140	5140	6140	7140	8140	9140	10140	11140	12140
#/8VP1500	150.0	6.00	2150	3150	4150	5150	6150	7150	8150	9150	10150	11150	12150
#/8VP1600	160.0	6.33	2160	3160	4160	5160	6160	7160	8160	9160	10160	11160	12160
#/8VP1700	170.0	6.75	2170	3170	4170	5170	6170	7170	8170	9170	10170	11170	12170
#/8VP1800	180.0	7.25	2180	3180	4180	5180	6180	7180	8180	9180	10180	11180	12180
#/8VP1900	190.0	7.65	2190	3190	4190	5190	6190	7190	8190	9190	10190	11190	12190
#/8VP2000	200.0	8.00	2200	3200	4200	5200	6200	7200	8200	9200	10200	11200	12200
#/8VP2120	212.0	8.50	2212	3212	4212	5212	6212	7212	8212	9212	10212	11212	12212
#/8VP2240	224.0	9.00	2224	3224	4224	5224	6224	7224	8224	9224	10224	11224	12224
#/8VP2360	236.0	9.42	2236	3236	4236	5236	6236	7236	8236	9236	10236	11236	12236
#/8VP2500	250.0	10.0	2250	3250	4250	5250	6250	7250	8250	9250	10250	11250	12250
#/8VP2650	265.0	10.5	2265	3265	4265	5265	6265	7265	8265	9265	10265	11265	12265
#/8VP2800	280.0	11.3	2280	3280	4280	5280	6280	7280	8280	9280	10280	11280	12280
#/8VP3000	300.0	12.0	2300	3300	4300	5300	6300	7300	8300	9300	10300	11300	12300
#/8VP3150	315.0	12.7	2315	3315	4315	5315	6315	7315	8315	9315	10315	11315	12315
#/8VP3350	335.0	13.5	2335	3335	4335	5335	6335	7335	8335	9335	10335	11335	12335
#/8VP3550	355.0	14.3	2355	3355	4355	5355	6355	7355	8355	9355	10355	11355	12355
#/8VP3750	375.0	15.0	2375	3375	4375	5375	6375	7375	8375	9375	10375	11375	12375
#/8VP4000	400.0	16.0	2400	3400	4400	5400	6400	7400	8400	9400	10400	11400	12400
#/8VP4250	425.0	17.0	2425	3425	4425	5425	6425	7425	8425	9425	10425	11425	12425
#/8VP4500	450.0	18.0	2450	3450	4450	5450	6450	7450	8450	9450	10450	11450	12450
#/8VP4750	475.0	19.1	2475	3475	4475	5475	6475	7475	8475	9475	10475	11475	12475
#/8VP5000	500.0	20.1	2500	3500	4500	5500	6500	7500	8500	9500	10500	11500	12500
#/8VP5600	560.0	22.7	2560	3560	4560	5560	6560	7560	8560	9560	10560	11560	12560
#/8VP6000	600.0	24.4	2600	3600	4600	5600	6600	7600	8600	9600	10600	11600	12600

POLEAS SUPER HC® QD®

MERCADOS / APLICACIONES

Para uso con bandas Super HC® y Super HC® Power Band®

CARACTERÍSTICAS / VENTAJAS

- El deslizamiento completo de los bujes permite que su instalación y remoción sean fáciles.
- El diseño preciso de la polea produce una compresión positiva en la flecha.
- El diseño más angosto de la polea es manufacturado con precisión y balanceado estáticamente que transmite mayor potencia.



Notas: Las poleas y los bujes deben ser ordenados por separado. Las poleas 8V son órdenes de producción. ADVERTENCIA: NO se usen estas poleas a velocidades superiores 3,300 cm/seg.

SECCIÓN 3V

DESCRIPCIÓN	CÓDIGO	NO. RANURAS	BUJE	DIÁM. MÁX. BARRENO (PULG.)	ANCHO (PULG.)	PESO (LBS.)	DESCRIPCIÓN	CÓDIGO	NO. RANURAS	BUJE	DIÁM. MÁX. BARRENO (PULG.)	ANCHO (PULG.)	PESO (LBS.)
QD1/3V2.20	78721022	1	JA	1 3/16	11/16	0.63	QD3/3V3.15	78723031	3	SH	1 5/8	1 1/2	2.25
QD2/3V2.20	78722022	2	JA	1 3/16	1 3/32	0.8	QD4/3V3.15	78724031	4	SH	1 5/8	1 29/32	2.42
QD1/3V2.35	78721023	1	JA	1 3/16	11/16	0.8	QD1/3V3.35	78721033	1	JA	1 3/16	11/16	1.6
QD2/3V2.35	78722023	2	JA	1 3/16	1 3/32	0.96	QD2/3V3.35	78722033	2	SH	1 5/8	1 3/32	1
QD1/3V2.50	78721025	1	JA	1 3/16	11/16	0.97	QD3/3V3.35	78723033	3	SH	1 5/8	1 1/2	1.51
QD2/3V2.50	78722025	2	JA	1 3/16	1 3/32	1.18	QD4/3V3.35	78724033	4	SH	1 5/8	1 29/32	2.23
QD3/3V2.50	78723025	3	JA	1 3/16	1 1/2	1.35	QD1/3V3.65	78721036	1	SH	1 5/8	11/16	1.59
QD1/3V2.65	78721026	1	JA	1 3/16	11/16	0.78	QD2/3V3.65	78722036	2	SH	1 5/8	1 3/32	1.41
QD2/3V2.65	78722026	2	JA	1 3/16	1 3/32	0.62	QD3/3V3.65	78723036	3	SH	1 5/8	1 1/2	2.12
QD3/3V2.65	78723026	3	JA	1 3/16	1 1/2	1.16	QD4/3V3.65	78724036	4	SH	1 5/8	1 29/32	2.16
QD4/3V2.65	78724026	4	JA	1 3/16	1 29/32	1.42	QD1/3V4.12	78721041	1	SH	1 5/8	11/16	2.06
QD1/3V2.80	78721028	1	JA	1 3/16	11/16	0.92	QD2/3V4.12	78722041	2	SH	1 5/8	1 3/32	2.26
QD2/3V2.80	78722028	2	JA	1 3/16	1 3/32	0.79	QD3/3V4.12	78723041	3	SH	1 5/8	1 1/2	2.64
QD3/3V2.80	78723028	3	JA	1 3/16	1 1/2	1.36	QD4/3V4.12	78724041	4	SH	1 5/8	1 29/32	3.05
QD4/3V2.80	78724028	4	JA	1 3/16	1 29/32	1.68	QD1/3V4.50	78721045	1	SH	1 5/8	11/16	2.6
QD1/3V3.00	78721030	1	JA	1 3/16	11/16	1.18	QD2/3V4.50	78722045	2	SH	1 5/8	1 3/32	2.81
QD2/3V3.00	78722030	2	JA	1 3/16	1 3/32	1.01	QD3/3V4.50	78723045	3	SDS	1 15/16	1 1/2	3
QD3/3V3.00	78723030	3	SH	1 5/8	1 1/2	1.86	QD4/3V4.50	78724045	4	SDS	1 15/16	1 29/32	3.47
QD4/3V3.00	78724030	4	SH	1 5/8	1 29/32	2.03	QD1/3V4.75	78721047	1	SH	1 5/8	11/16	3
QD1/3V3.15	78721031	1	JA	1 3/16	11/16	1.32	QD2/3V4.75	78722047	2	SH	1 5/8	1 3/32	3.21
QD2/3V3.15	78722031	2	JA	1 3/16	1 3/32	1.18	QD3/3V4.75	78723047	3	SDS	1 15/16	1 1/2	3.38

SECCIÓN 3V

DESCRIPCIÓN	CÓDIGO	NO. RAN-URAS	BUJE	DIÁM. MÁX. BARRENO (PULG.)	ANCHO (PULG.)	PESO (LBS.)	DESCRIPCIÓN	CÓDIGO	NO. RAN-URAS	BUJE	DIÁM. MÁX. BARRENO (PULG.)	ANCHO (PULG.)	PESO (LBS.)
QD4/3V4.75	78724047	4	SDS	1 15/16	1 29/32	4.04	QD5/3V6.00	78725060	5	SK	2 1/2	2 5/16	9.11
QD5/3V4.75	78725047	5	SDS	1 15/16	2 5/16	4.33	QD6/3V6.00	78726060	6	SK	2 1/2	2 23/32	10.15
QD6/3V4.75	78726047	6	SK	2 1/2	2 23/32	5.28	QD8/3V6.00	78728060	8	SK	2 1/2	3 17/32	10
QD8/3V4.75	78728047	8	SK	2 1/2	3 17/32	6.94	QD10/3V6.00	78730060	10	SK	2 1/2	4 11/32	11.39
QD10/3V4.75	78730047	10	SK	2 1/2	4 11/32	7.42	QD1/3V6.50	78721065	1	SH	1 5/8	1 1/16	6.1
QD1/3V5.00	78721050	1	SH	1 5/8	1 1/16	3.3	QD2/3V6.50	78722065	2	SDS	1 5/8	1 3/32	6.46
QD2/3V5.00	78722050	2	SH	1 5/8	1 3/32	3.64	QD3/3V6.50	78723065	3	SDS	1 15/16	1 1/2	8.2
QD3/3V5.00	78723050	3	SDS	1 15/16	1 1/2	3.92	QD4/3V6.50	78724065	4	SK	2 1/2	1 29/32	9.61
QD4/3V5.00	78724050	4	SDS	1 15/16	1 29/32	4.59	QD5/3V6.50	78725065	5	SK	2 1/2	2 5/16	10.72
QD5/3V5.00	78725050	5	SDS	1 15/16	2 5/16	5.15	QD6/3V6.50	78726065	6	SK	2 1/2	2 23/32	11.77
QD6/3V5.00	78726050	6	SK	2 1/2	2 23/32	6.09	QD8/3V6.50	78728065	8	SK	2 1/2	3 17/32	14.35
QD8/3V5.00	78728050	8	SK	2 1/2	3 17/32	7.47	QD10/3V6.50	78730065	10	SK	2 1/2	4 11/32	14.32
QD10/3V5.00	78730050	10	SK	2 1/2	4 11/32	8.67	QD1/3V6.90	78721069	1	SH	1 5/8	1 1/16	6.93
QD1/3V5.30	78721053	1	SH	1 5/8	1 1/16	3.79	QD2/3V6.90	78722069	2	SDS	1 5/8	1 3/32	7.28
QD2/3V5.30	78722053	2	SH	1 5/8	1 3/32	4.18	QD3/3V6.90	78723069	3	SDS	1 15/16	1 1/2	8.91
QD3/3V5.30	78723053	3	SDS	1 15/16	1 1/2	4.51	QD4/3V6.90	78724069	4	SK	2 1/2	1 29/32	11.08
QD4/3V5.30	78724053	4	SDS	1 15/16	1 29/32	5.22	QD5/3V6.90	78725069	5	SK	2 1/2	2.3125	13.04
QD5/3V5.30	78725053	5	SK	2 1/2	2 5/16	5.99	QD6/3V6.90	78726069	6	SK	2 1/2	2 23/32	14.51
QD6/3V5.30	78726053	6	SK	2 1/2	2 23/32	6.6	QD8/3V6.90	78728069	8	SK	2 1/2	3 17/32	14.09
QD8/3V5.30	78728053	8	SK	2 1/2	3 17/32	7.55	QD10/3V6.90	78730069	10	SK	2 1/2	4 11/32	16.4
QD10/3V5.30	78730053	10	SK	2 1/2	4 11/32	8.74	QD1/3V8.00	78721080	1	SDS	1 15/16	1 1/16	8.21
QD1/3V5.60	78721056	1	SH	1 5/8	1 1/16	4.35	QD2/3V8.00	78722080	2	SDS	1 15/16	1 3/32	10.03
QD2/3V5.60	78722056	2	SH	1 5/8	1 3/32	4.69	QD3/3V8.00	78723080	3	SK	2 1/2	1 1/2	14.44
QD3/3V5.60	78723056	3	SDS	1 15/16	1 1/2	4.98	QD4/3V8.00	78724080	4	SK	2 1/2	1 29/32	16.56
QD4/3V5.60	78724056	4	SDS	1 15/16	1 29/32	5.64	QD5/3V8.00	78725080	5	SK	2 1/2	2 5/16	17.99
QD5/3V5.60	78725056	5	SK	2 1/2	2 5/16	6.99	QD6/3V8.00	78726080	6	SK	2 1/2	2 23/32	16.93
QD6/3V5.60	78726056	6	SK	2 1/2	2 23/32	7.69	QD8/3V8.00	78728080	8	SF	2 15/16	3 17/32	19.68
QD8/3V5.60	78728056	8	SK	2 1/2	3 17/32	9.35	QD10/3V8.00	78730080	10	SF	2 15/16	4 11/32	19
QD10/3V5.60	78730056	10	SK	2 1/2	4 11/32	11	QD1/3V10.60	78721106	1	SDS	1 15/16	1 1/16	14.13
QD1/3V6.00	78721060	1	SH	1 5/8	1 1/16	5.05	QD2/3V10.60	78722106	2	SK	1 15/16	1 3/32	19.8
QD2/3V6.00	78722060	2	SH	1 5/8	1 3/32	5.7	QD3/3V10.60	78723106	3	SK	2 1/2	1 1/2	16.1
QD3/3V6.00	78723060	3	SDS	1 15/16	1 1/2	7.1	QD4/3V10.60	78724106	4	SK	2 1/2	1 29/32	17.29
QD4/3V6.00	78724060	4	SK	2 1/2	1 29/32	7.93	QD5/3V10.60	78725106	5	SK	2 1/2	2 5/16	32.74

SECCIÓN 5V

DESCRIPCIÓN	CÓDIGO	NO. RANURAS	BUJE	DIÁM. MÁX. BARRENO (PULG.)	ANCHO (PULG.)	PESO (LBS.)	DESCRIPCIÓN	CÓDIGO	NO. RANURAS	BUJE	DIÁM. MÁX. BARRENO (PULG.)	ANCHO (PULG.)	PESO (LBS.)
QD6/3V10.60	78726106	6	SF	2 15/16	2 23/32	35.49	QD3/5V4.90	78743049	3	SDS	1 15/16	2 3/8	5
QD8/3V10.60	78728106	8	SF	2 15/16	3 17/32	24.87	QD4/5V4.90	78744049	4	SD	1 15/16	3 1/16	6.6
QD10/3V10.60	78730106	10	E	3 1/2	4 11/32	31.29	QD5/5V4.90	78745049	5	SD	1 15/16	3 3/4	8.58
QD1/3V14.00	78721140	1	SK	2 1/2	1 1/16	17.53	QD6/5V4.90	78746049	6	SD	1 15/16	4 7/16	10.32
QD2/3V14.00	78722140	2	SK	2 1/2	1 3/32	14.82	QD2/5V5.20	78742052	2	SDS	1 15/16	1 11/16	4.55
QD3/3V14.00	78723140	3	SK	2 1/2	1 1/2	20.33	QD3/5V5.20	78743052	3	SDS	1 15/16	2 3/8	5.79
QD4/3V14.00	78724140	4	SK	2 1/2	1 29/32	26.13	QD4/5V5.20	78744052	4	SD	1 15/16	3 1/16	7.7
QD5/3V14.00	78725140	5	SF	2 15/16	2 5/16	30.47	QD5/5V5.20	78745052	5	SD	1 15/16	3 3/4	8.69
QD6/3V14.00	78726140	6	SF	2 15/16	2 23/32	33.26	QD6/5V5.20	78746052	6	SD	1 15/16	4 7/16	10.28
QD8/3V14.00	78728140	8	E	3 1/2	3 17/32	45.54	QD2/5V5.50	78742055	2	SDS	1 15/16	1 11/16	5.15
QD10/3V14.00	78730140	10	E	3 1/2	4 11/32	49.7	QD3/5V5.50	78743055	3	SDS	1 15/16	2 3/8	6.47
QD1/3V19.00	78721190	1	SK	2 1/2	1 1/16	34.81	QD4/5V5.50	78744055	4	SD	1 15/16	3 1/16	9.15
QD2/3V19.00	78722190	2	SK	2 1/2	1 3/32	35.06	QD5/5V5.50	78745055	5	SD	1 15/16	3 3/4	10.24
QD3/3V19.00	78723190	3	SF	2 15/16	1 1/2	34.3	QD6/5V5.50	78746055	6	SD	1 15/16	4 7/16	11.53
QD4/3V19.00	78724190	4	SF	2 15/16	1 29/32	36.99	QD2/5V5.90	78742059	2	SDS	1 15/16	1 11/16	6.16
QD5/3V19.00	78725190	5	SF	2 15/16	2 5/16	43.65	QD3/5V5.90	78743059	3	SDS	1 15/16	2 3/8	7.87
QD6/3V19.00	78726190	6	E	3 1/2	2 23/32	50.77	QD4/5V5.90	78744059	4	SD	1 15/16	3 1/16	10.25
QD8/3V19.00	78728190	8	E	3 1/2	3 17/32	60.75	QD5/5V5.90	78745059	5	SK	2 1/2	3 3/4	10.82
QD10/3V19.00	78730190	10	E	3 1/2	4 11/32	72.3	QD6/5V5.90	78746059	6	SK	2 1/2	4 7/16	12.3
QD2/3V25.00	78722250	2	SF	2 15/16	1 3/32	33.75	QD2/5V6.30	78742063	2	SK	2 1/2	1 11/16	7.6
QD3/3V25.00	78723250	3	SF	2 15/16	1 1/2	51.5	QD3/5V6.30	78743063	3	SK	2 1/2	2 3/8	9.57
QD4/3V25.00	78724250	4	SF	2 15/16	1 29/32	49	QD4/5V6.30	78744063	4	SK	2 1/2	3 1/16	11.01
QD5/3V25.00	78725250	5	E	3 1/2	2 5/16	68	QD5/5V6.30	78745063	5	SK	2 1/2	3 3/4	12.7
QD6/3V25.00	78726250	6	E	3 1/2	2 23/32	66.5	QD6/5V6.30	78746063	6	SK	2 1/2	4 7/16	14.17
QD8/3V25.00	78728250	8	E	3 1/2	3 17/32	84.5	QD2/5V6.70	78742067	2	SK	2 1/2	1 11/16	8.96
QD10/3V25.00	78730250	10	F	3 15/16	4 11/32	98.6	QD3/5V6.70	78743067	3	SK	2 1/2	2 3/8	10.62
QD3/3V33.50	78723335	3	SF	2 15/16	1 1/2	75.5	QD4/5V6.70	78744067	4	SK	2 1/2	3 1/16	12.33
QD4/3V33.50	78724335	4	E	3 1/2	1 29/32	96	QD5/5V6.70	78745067	5	SF	2 15/16	3 3/4	13.84
QD5/3V33.50	78725335	5	E	3 1/2	2 5/16	97.5	QD6/5V6.70	78746067	6	SF	2 15/16	4 7/16	16
QD6/3V33.50	78726335	6	E	3 1/2	2 23/32	105	QD2/5V7.10	78742071	2	SK	2 1/2	1 11/16	10.31
QD8/3V33.50	78728335	8	F	3 15/16	3 17/32	137	QD3/5V7.10	78743071	3	SF	2 15/16	2 3/8	12.35
QD10/3V33.50	78730335	10	F	3 15/16	4 11/32	178	QD4/5V7.10	78744071	4	SF	2 15/16	3 1/16	14.82
QD2/5V4.40	78742044	2	SH	1 5/8	1 11/16	3.27	QD5/5V7.10	78745071	5	SF	2 15/16	3 3/4	16.74
QD3/5V4.40	78743044	3	SDS	1 15/16	2 3/8	4.41	QD6/5V7.10	78746071	6	SF	2 15/16	4 7/16	17.79
QD4/5V4.40	78744044	4	SD	1 15/16	3 1/16	5.53	QD7/5V7.10	78747071	7	SF	2 15/16	5 1/8	18.8
QD5/5V4.40	78745044	5	SD	1 15/16	3 3/4	6.42	QD8/5V7.10	78748071	8	SF	2 15/16	5 13/16	21.78
QD6/5V4.40	78746044	6	SD	1 15/16	4 7/16	7.45	QD2/5V7.50	78742075	2	SK	2 1/2	1 11/16	11.77
QD2/5V4.65	78742046	2	SDS	1 15/16	1 11/16	4.16	QD3/5V7.50	78743075	3	SF	2 15/16	2 3/8	13.23
QD3/5V4.65	78743046	3	SDS	1 15/16	2 3/8	4.51	QD4/5V7.50	78744075	4	SF	2 15/16	3 1/16	15.34
QD4/5V4.65	78744046	4	SD	1 15/16	3 1/16	6.7	QD5/5V7.50	78745075	5	SF	2 15/16	3 3/4	17.98
QD5/5V4.65	78745046	5	SD	1 15/16	3 3/4	7.94	QD6/5V7.50	78746075	6	SF	2 15/16	4 7/16	21.74
QD6/5V4.65	78746046	6	SD	1 15/16	4 7/16	8.54	QD7/5V7.50	78747075	7	SF	2 15/16	5 1/8	22
QD2/5V4.90	78742049	2	SDS	1 15/16	1 11/16	3.95							

SECCIÓN 5V

DESCRIPCIÓN	CÓDIGO	NO. RANURAS	BUJE	DIÁM. MÁX. BARRENO (PULG.)	ANCHO (PULG.)	PESO (LBS.)	DESCRIPCIÓN	CÓDIGO	NO. RANURAS	BUJE	DIÁM. MÁX. BARRENO (PULG.)	ANCHO (PULG.)	PESO (LBS.)
QD8/5V7.50	78748075	8	SF	2 15/16	5 13/16	28.04	QD8/5V9.75	78748097	8	F	3 15/16	5 13/16	53.57
QD2/5V8.00	78742080	2	SK	2 1/2	1 11/16	14.21	QD9/5V9.75	78749097	9	F	3 15/16	6 1/2	48
QD3/5V8.00	78743080	3	SF	2 15/16	2 3/8	16.68	QD10/5V9.75	78750097	10	F	3 15/16	7 3/16	51.62
QD4/5V8.00	78744080	4	E	3 1/2	3 1/16	18.1	QD2/5V10.30	78742103	2	SK	2 1/2	1 11/16	20.65
QD5/5V8.00	78745080	5	E	3 1/2	3 3/4	20.22	QD3/5V10.30	78743103	3	SF	2 15/16	2 3/8	22.65
QD6/5V8.00	78746080	6	E	3 1/2	4 7/16	22.57	QD4/5V10.30	78744103	4	E	3 1/2	3 1/16	33.48
QD7/5V8.00	78747080	7	E	3 1/2	5 1/8	25	QD5/5V10.30	78745103	5	E	3 1/2	3 3/4	37.53
QD8/5V8.00	78748080	8	E	3 1/2	5 13/16	27.48	QD6/5V10.30	78746103	6	E	3 1/2	4 7/16	43.44
QD9/5V8.00	78749080	9	E	3 1/2	6 1/2	29	QD7/5V10.30	78747103	7	F	3 15/16	5 1/8	49
QD10/5V8.00	78750080	10	E	3 1/2	7 3/16	31.41	QD8/5V10.30	78748103	8	F	3 15/16	5 13/16	53.39
QD2/5V8.50	78742085	2	SK	2 1/2	1 11/16	13.07	QD9/5V10.30	78749103	9	F	3 15/16	6 1/2	55
QD3/5V8.50	78743085	3	SF	2 15/16	2 3/8	17.78	QD10/5V10.30	78750103	10	F	3 15/16	7 3/16	58.3
QD4/5V8.50	78744085	4	E	3 1/2	3 1/16	20.84	QD2/5V10.90	78742109	2	SK	2 1/2	1 11/16	19.41
QD5/5V8.50	78745085	5	E	3 1/2	3 3/4	24.35	QD3/5V10.90	78743109	3	SF	2 15/16	2 3/8	25.16
QD6/5V8.50	78746085	6	E	3 1/2	4 7/16	27.39	QD4/5V10.90	78744109	4	E	3 1/2	3 1/16	37.33
QD7/5V8.50	78747085	7	E	3 1/2	5 1/8	28	QD5/5V10.90	78745109	5	E	3 1/2	3 3/4	41.75
QD8/5V8.50	78748085	8	E	3 1/2	5 13/16	36.55	QD6/5V10.90	78746109	6	E	3 1/2	4 7/16	43.74
QD9/5V8.50	78749085	9	E	3 1/2	6 1/2	33	QD7/5V10.90	78747109	7	F	3 15/16	5 1/8	55
QD10/5V8.50	78750085	10	E	3 1/2	7 3/16	42.44	QD8/5V10.90	78748109	8	F	3 15/16	5 13/16	53
QD2/5V9.00	78742090	2	SK	2 1/2	1 11/16	15.8	QD9/5V10.90	78749109	9	F	3 15/16	6 1/2	61
QD3/5V9.00	78743090	3	SF	2 15/16	2 3/8	21.88	QD10/5V10.90	78750109	10	F	3 15/16	7 3/16	84.3
QD4/5V9.00	78744090	4	E	3 1/2	3 1/16	25.95	QD2/5V11.30	78742113	2	SK	2 1/2	1 11/16	22.77
QD5/5V9.00	78745090	5	E	3 1/2	3 3/4	26.75	QD3/5V11.30	78743113	3	SF	2 15/16	2 3/8	28.46
QD6/5V9.00	78746090	6	E	3 1/2	4 7/16	29.85	QD4/5V11.30	78744113	4	E	3 1/2	3 1/16	41.12
QD7/5V9.00	78747090	7	E	3 1/2	5 1/8	32	QD5/5V11.30	78745113	5	E	3 1/2	3 3/4	47.9
QD8/5V9.00	78748090	8	E	3 1/2	5 13/16	34.74	QD6/5V11.30	78746113	6	E	3 1/2	4 7/16	50.67
QD9/5V9.00	78749090	9	E	3 1/2	6 1/2	37	QD7/5V11.30	78747113	7	F	3 15/16	5 1/8	62
QD10/5V9.00	78750090	10	F	3 15/16	7 3/16	43.66	QD8/5V11.30	78748113	8	F	3 15/16	5 13/16	76.94
QD2/5V9.25	78742092	2	SK	2 1/2	1 11/16	19.45	QD9/5V11.30	78749113	9	F	3 15/16	6 1/2	69
QD3/5V9.25	78743092	3	SF	2 15/16	2 3/8	21.3	QD10/5V11.30	78750113	10	F	3 15/16	7 3/16	75.4
QD4/5V9.25	78744092	4	E	3 1/2	3 1/16	25.87	QD2/5V11.80	78742118	2	SK	2 1/2	1 11/16	28.1
QD5/5V9.25	78745092	5	E	3 1/2	3 3/4	28.32	QD3/5V11.80	78743118	3	SF	2 15/16	2 3/8	27.29
QD6/5V9.25	78746092	6	E	3 1/2	4 7/16	31.26	QD4/5V11.80	78744118	4	E	3 1/2	3 1/16	36.84
QD7/5V9.25	78747092	7	E	3 1/2	5 1/8	33	QD5/5V11.80	78745118	5	E	3 1/2	3 3/4	39.27
QD8/5V9.25	78748092	8	F	3 15/16	5 13/16	43.35	QD6/5V11.80	78746118	6	E	3 1/2	4 7/16	46.86
QD9/5V9.25	78749092	9	F	3 15/16	6 1/2	42	QD7/5V11.80	78747118	7	F	3 15/16	5 1/8	52
QD10/5V9.25	78750092	10	F	3 15/16	7 3/16	48.23	QD8/5V11.80	78748118	8	F	3 15/16	5 13/16	71.7
QD2/5V9.75	78742097	2	SK	2 1/2	1 11/16	22.54	QD9/5V11.80	78749118	9	F	3 15/16	6 1/2	60
QD3/5V9.75	78743097	3	SF	2 15/16	2 3/8	22.04	QD10/5V11.80	78750118	10	F	3 15/16	7 3/16	90.94
QD4/5V9.75	78744097	4	E	3 1/2	3 1/16	29.15	QD2/5V12.50	78742125	2	SF	2 1/2	1 11/16	24.87
QD5/5V9.75	78745097	5	E	3 1/2	3 3/4	33.29	QD3/5V12.50	78743125	3	E	3 1/2	2 3/8	36.96
QD6/5V9.75	78746097	6	E	3 1/2	4 7/16	34.98	QD4/5V12.50	78744125	4	E	3 1/2	3 1/16	37.54
QD7/5V9.75	78747097	7	E	3 1/2	5 1/8	37	QD5/5V12.50	78745125	5	E	3 1/2	3 3/4	41.46

SECCIÓN 5V

DESCRIPCIÓN	CÓDIGO	NO. RANURAS	BUJE	DIÁM. MÁX. BARRENO (PULG.)	ANCHO (PULG.)	PESO (LBS.)	DESCRIPCIÓN	CÓDIGO	NO. RANURAS	BUJE	DIÁM. MÁX. BARRENO (PULG.)	ANCHO (PULG.)	PESO (LBS.)
QD6/5V12.50	78746125	6	F	3 15/16	4 7/16	62.9	QD4/5V18.70	78744187	4	E	3 1/2	3 1/16	70.72
QD7/5V12.50	78747125	7	F	3 15/16	5 1/8	58	QD5/5V18.70	78745187	5	F	3 15/16	3 3/4	85
QD8/5V12.50	78748125	8	F	3 15/16	5 13/16	90.18	QD6/5V18.70	78746187	6	F	3 15/16	4 7/16	152
QD9/5V12.50	78749125	9	F	3 15/16	6 1/2	66	QD7/5V18.70	78747187	7	F	3 15/16	5 1/8	88
QD10/5V12.50	78750125	10	J	4 1/2	7 3/16	116	QD8/5V18.70	78748187	8	J	4 1/2	5 13/16	128
QD2/5V13.20	78742132	2	SF	2 15/16	1 11/16	27.64	QD9/5V18.70	78749187	9	J	4 1/2	6 1/2	110
QD3/5V13.20	78743132	3	E	3 1/2	2 3/8	40.07	QD10/5V18.70	78750187	10	J	4 1/2	7 3/16	200
QD4/5V13.20	78744132	4	E	3 1/2	3 1/16	39.66	QD2/5V21.20	78742212	2	SF	2 15/16	1 11/16	46
QD5/5V13.20	78745132	5	E	3 1/2	3 3/4	44.73	QD3/5V21.20	78743212	3	E	3 1/2	2 3/8	62
QD6/5V13.20	78746132	6	F	3 15/16	4 7/16	61.44	QD4/5V21.20	78744212	4	E	3 1/2	3 1/16	71
QD7/5V13.20	78747132	7	F	3 15/16	5 1/8	63	QD5/5V21.20	78745212	5	F	3 15/16	3 3/4	105
QD8/5V13.20	78748132	8	F	3 15/16	5 13/16	92	QD6/5V21.20	78746212	6	F	3 15/16	4 7/16	101
QD9/5V13.20	78749132	9	F	3 15/16	6 1/2	72	QD7/5V21.20	78747212	7	J	4 1/2	5 1/8	113
QD10/5V13.20	78750132	10	J	4 1/2	7 3/16	125	QD8/5V21.20	78748212	8	J	4 1/2	5 13/16	145
QD2/5V14.00	78742140	2	SF	2 15/16	1 11/16	30.69	QD9/5V21.20	78749212	9	J	4 1/2	6 1/2	127
QD3/5V14.00	78743140	3	E	3 1/2	2 3/8	39.06	QD10/5V21.20	78750212	10	J	4 1/2	7 3/16	188
QD4/5V14.00	78744140	4	E	3 1/2	3 1/16	46.66	QD2/5V23.60	78742236	2	E	3 1/2	1 11/16	121
QD5/5V14.00	78745140	5	E	3 1/2	3 3/4	52.8	QD3/5V23.60	78743236	3	E	3 1/2	2 3/8	69
QD6/5V14.00	78746140	6	F	3 15/16	4 7/16	68.72	QD4/5V23.60	78744236	4	F	3 15/16	3 1/16	110
QD7/5V14.00	78747140	7	F	3 15/16	5 1/8	67	QD5/5V23.60	78745236	5	F	3 15/16	3 3/4	120
QD8/5V14.00	78748140	8	F	3 15/16	5 13/16	118	QD6/5V23.60	78746236	6	J	4 1/2	4 7/16	142
QD9/5V14.00	78749140	9	F	3 15/16	6 1/2	78	QD7/5V23.60	78747236	7	J	4 1/2	5 1/8	123
QD10/5V14.00	78750140	10	J	4 1/2	7 3/16	145	QD8/5V23.60	78748236	8	J	4 1/2	5 13/16	165
QD2/5V15.00	78742150	2	SF	2 15/16	1 11/16	34.57	QD9/5V23.60	78749236	9	J	4 1/2	6 1/2	145
QD3/5V15.00	78743150	3	E	3 1/2	2 3/8	41.55	QD10/5V23.60	78750236	10	M	5 1/2	7 3/16	217
QD4/5V15.00	78744150	4	E	3 1/2	3 1/16	51.35	QD2/5V28.00	78742280	2	E	3 1/2	1 11/16	94.08
QD5/5V15.00	78745150	5	E	3 1/2	3 3/4	53.79	QD3/5V28.00	78743280	3	E	3 1/2	2 3/8	93.99
QD6/5V15.00	78746150	6	F	3 15/16	4 7/16	75.74	QD4/5V28.00	78744280	4	F	3 15/16	3 1/16	128
QD7/5V15.00	78747150	7	F	3 15/16	5 1/8	66	QD5/5V28.00	78745280	5	F	3 15/16	3 3/4	141
QD8/5V15.00	78748150	8	F	3 15/16	5 13/16	86.56	QD6/5V28.00	78746280	6	J	4 1/2	4 7/16	151
QD9/5V15.00	78749150	9	J	4 1/2	6 1/2	91	QD7/5V28.00	78747280	7	J	4 1/2	5 1/8	162
QD10/5V15.00	78750150	10	J	4 1/2	7 3/16	180	QD8/5V28.00	78748280	8	J	4 1/2	5 13/16	178
QD2/5V16.00	78742160	2	SF	2 15/16	1 11/16	36.58	QD9/5V28.00	78749280	9	M	5 1/2	6 1/2	230
QD3/5V16.00	78743160	3	E	3 1/2	2 3/8	43.96	QD10/5V28.00	78750280	10	M	5 1/2	7 3/16	260
QD4/5V16.00	78744160	4	E	3 1/2	3 1/16	54.57	QD3/5V31.50	78743315	3	F	3 15/16	2 3/8	110
QD5/5V16.00	78745160	5	E	3 1/2	3 3/4	59.56	QD4/5V31.50	78744315	4	F	3 15/16	3 1/16	145
QD6/5V16.00	78746160	6	F	3 15/16	4 7/16	79.82	QD5/5V31.50	78745315	5	J	4 1/2	3 3/4	165.9
QD7/5V16.00	78747160	7	F	3 15/16	5 1/8	71	QD6/5V31.50	78746315	6	J	4 1/2	4 7/16	190
QD8/5V16.00	78748160	8	F	3 15/16	5 13/16	88	QD7/5V31.50	78747315	7	J	4 1/2	5 1/8	192
QD9/5V16.00	78749160	9	J	4 1/2	6 1/2	91	QD8/5V31.50	78748315	8	M	5 1/2	5 13/16	286
QD10/5V16.00	78750160	10	J	4 1/2	7 3/16	200	QD9/5V31.50	78749315	9	M	5 1/2	6 1/2	281
QD2/5V18.70	78742187	2	SF	2 15/16	1 11/16	53.9	QD10/5V31.50	78750315	10	M	5 1/2	7 3/16	286
QD3/5V18.70	78743187	3	E	3 1/2	2 3/8	64.51	QD3/5V37.50	78743375	3	F	3 15/16	2 3/8	144

SECCIÓN 5V

DESCRIPCIÓN	CÓDIGO	NO. RANURAS	BUJE	DIÁM. MÁX. BARRENO (PULG.)	ANCHO (PULG.)	PESO (LBS.)	DESCRIPCIÓN	CÓDIGO	NO. RANURAS	BUJE	DIÁM. MÁX. BARRENO (PULG.)	ANCHO (PULG.)	PESO (LBS.)
QD4/5V37.50	78744375	4	F	3 15/16	3 1/16	180.5	QD4/5V50.00	78744500	4	J	4 1/2	3 1/16	328
QD5/5V37.50	78745375	5	J	4 1/2	3 3/4	225.5	QD5/5V50.00	78745500	5	J	4 1/2	3 3/4	290
QD6/5V37.50	78746375	6	J	4 1/2	4 7/16	235	QD6/5V50.00	78746500	6	M	5 1/2	4 7/16	360
QD7/5V37.50	78747375	7	M	5 1/2	5 1/8	304	QD7/5V50.00	78747500	7	M	5 1/2	5 1/8	477
QD8/5V37.50	78748375	8	M	5 1/2	5 13/16	324	QD8/5V50.00	78748500	8	M	5 1/2	5 13/16	444
QD9/5V37.50	78749375	9	M	5 1/2	6 1/2	335	QD9/5V50.00	78749500	9	M	5 1/2	6 1/2	520
QD10/5V37.50	78750375	10	M	5 1/2	7 3/16	340	QD10/5V50.00	78750500	10	M	5 1/2	7 3/16	540
QD3/5V50.00	78743500	3	F	3 15/16	2 3/8	420							

SECCIÓN 8V

DESCRIPCIÓN	CÓDIGO	NO. RANURAS	BUJE	DIÁM. MÁX. BARRENO (PULG.)	ANCHO (PULG.)	PESO (LBS.)	DESCRIPCIÓN	CÓDIGO	NO. RANURAS	BUJE	DIÁM. MÁX. BARRENO (PULG.)	ANCHO (PULG.)	PESO (LBS.)
QD4/8V12.50	78764125	4	F	3 15/16	4 7/8	74.65	QD4/8V17.00	78764170	4	F	3 15/16	4 7/8	150
QD5/8V12.50	78765125	5	F	3 15/16	6	70	QD5/8V17.00	78765170	5	J	4 1/2	6	150
QD6/8V12.50	78766125	6	F	3 15/16	7 1/8	91.43	QD6/8V17.00	78766170	6	J	4 1/2	7 1/8	138
QD8/8V12.50	78768125	8	J	4 1/2	9 3/8	110	QD8/8V17.00	78768170	8	M	5 1/2	9 3/8	186
QD10/8V12.50	78770125	10	J	4 1/2	11 5/8	133	QD10/8V17.00	78770170	10	M	5 1/2	11 5/8	261
QD12/8V12.50	78772125	12	M	5 1/2	13 7/8	153	QD12/8V17.00	78772170	12	M	5 1/2	13 7/8	267
QD4/8V13.20	78764132	4	F	3 15/16	4 7/8	88	QD4/8V18.00	78764180	4	F	3 15/16	4 7/8	150
QD5/8V13.20	78765132	5	F	3 15/16	6	82.96	QD5/8V18.00	78765180	5	J	4 1/2	6	150
QD6/8V13.20	78766132	6	F	3 15/16	7 1/8	91	QD6/8V18.00	78766180	6	J	4 1/2	7 1/8	135
QD8/8V13.20	78768132	8	J	4 1/2	9 3/8	128	QD8/8V18.00	78768180	8	M	5 1/2	9 3/8	218
QD10/8V13.20	78770132	10	J	4 1/2	11 5/8	151	QD10/8V18.00	78770180	10	M	5 1/2	11 5/8	295
QD12/8V13.20	78772132	12	M	5 1/2	13 7/8	180	QD12/8V18.00	78772180	12	M	5 1/2	13 7/8	274
QD4/8V14.00	78764140	4	F	3 15/16	4 7/8	76.69	QD4/8V19.00	78764190	4	F	3 15/16	4 7/8	100
QD5/8V14.00	78765140	5	F	3 15/16	6	104	QD5/8V19.00	78765190	5	J	4 1/2	6	146
QD6/8V14.00	78766140	6	F	3 15/16	7 1/8	118	QD6/8V19.00	78766190	6	J	4 1/2	7 1/8	163
QD8/8V14.00	78768140	8	J	4 1/2	9 3/8	131	QD8/8V19.00	78768190	8	M	5 1/2	9 3/8	190
QD10/8V14.00	78770140	10	J	4 1/2	11 5/8	168	QD10/8V19.00	78770190	10	M	5 1/2	11 5/8	249
QD12/8V14.00	78772140	12	M	5 1/2	13 7/8	186	QD12/8V19.00	78772190	12	N	5 7/8	13 7/8	306
QD4/8V15.00	78764150	4	F	3 15/16	4 7/8	111	QD4/8V20.00	78764200	4	J	4 1/2	4 7/8	145
QD5/8V15.00	78765150	5	F	3 15/16	6	105.5	QD5/8V20.00	78765200	5	J	4 1/2	6	145
QD6/8V15.00	78766150	6	J	4 1/2	7 1/8	128	QD6/8V20.00	78766200	6	M	5 1/2	7 1/8	100
QD8/8V15.00	78768150	8	J	4 1/2	9 3/8	154	QD8/8V20.00	78768200	8	M	5 1/2	9 3/8	212
QD10/8V15.00	78770150	10	M	5 1/2	11 5/8	181	QD10/8V20.00	78770200	10	M	5 1/2	11 5/8	277
QD12/8V15.00	78772150	12	M	5 1/2	13 7/8	221	QD12/8V20.00	78772200	12	N	5 7/8	13 7/8	338
QD4/8V16.00	78764160	4	F	3 15/16	4 7/8	97	QD4/8V21.20	78764212	4	J	4 1/2	4 7/8	181
QD5/8V16.00	78765160	5	F	3 15/16	6	110	QD5/8V21.20	78765212	5	J	4 1/2	6	181
QD6/8V16.00	78766160	6	J	4 1/2	7 1/8	143	QD6/8V21.20	78766212	6	M	5 1/2	7 1/8	188
QD8/8V16.00	78768160	8	J	4 1/2	9 3/8	153	QD8/8V21.20	78768212	8	M	5 1/2	9 3/8	282
QD10/8V16.00	78770160	10	M	5 1/2	11 5/8	257	QD10/8V21.20	78770212	10	M	5 1/2	11 5/8	254
QD12/8V16.00	78772160	12	M	5 1/2	13 7/8	247	QD12/8V21.20	78772212	12	N	5 7/8	13 7/8	310

SECCIÓN 8V

DESCRIPCIÓN	CÓDIGO	NO. RANURAS	BUJE	DIÁM. MÁX. BARRENO (PULG.)	ANCHO (PULG.)	PESO (LBS.)	DESCRIPCIÓN	CÓDIGO	NO. RANURAS	BUJE	DIÁM. MÁX. BARRENO (PULG.)	ANCHO (PULG.)	PESO (LBS.)
QD4/8V22.40	78764224	4	J	4 1/2	4 7/8	199	QD5/8V40.00	78765400	5	M	5 1/2	6	471
QD5/8V22.40	78765224	5	J	4 1/2	6	199	QD6/8V40.00	78766400	6	N	5 7/8	7 1/8	519
QD6/8V22.40	78766224	6	M	5 1/2	7 1/8	221	QD8/8V40.00	78768400	8	N	5 7/8	9 3/8	592
QD8/8V22.40	78768224	8	M	5 1/2	9 3/8	258	QD10/8V40.00	78770400	10	P	7	11 5/8	697
QD10/8V22.40	78770224	10	N	5 7/8	11 5/8	326	QD12/8V40.00	78772400	12	P	7	13 7/8	796
QD12/8V22.40	78772224	12	N	5 7/8	13 7/8	361	QD4/8V44.50	78764445	4	M	5 1/2	4 7/8	369
QD4/8V24.80	78764248	4	M	5 1/2	4 7/8	220	QD5/8V44.50	78765445	5	N	5 7/8	6	427
QD5/8V24.80	78765248	5	M	5 1/2	6	232	QD6/8V44.50	78766445	6	N	5 7/8	7 1/8	510
QD6/8V24.80	78766248	6	M	5 1/2	7 1/8	302	QD8/8V44.50	78768445	8	P	7	9 3/8	691
QD8/8V24.80	78768248	8	N	5 7/8	9 3/8	362	QD10/8V44.50	78770445	10	P	7	11 5/8	754
QD10/8V24.80	78770248	10	N	5 7/8	11 5/8	336	QD12/8V44.50	78772445	12	P	7	13 7/8	839
QD12/8V24.80	78772248	12	N	5 7/8	13 7/8	313	QD4/8V53.00	78764530	4	M	5 1/2	4 7/8	818
QD4/8V30.00	78764300	4	M	5 1/2	4 7/8	292	QD5/8V53.00	78765530	5	N	5 7/8	6	613
QD5/8V30.00	78765300	5	M	5 1/2	6	295	QD6/8V53.00	78766530	6	N	5 7/8	7 1/8	924
QD6/8V30.00	78766300	6	M	5 1/2	7 1/8	345	QD8/8V53.00	78768530	8	P	7	9 3/8	1040
QD8/8V30.00	78768300	8	N	5 7/8	9 3/8	410	QD10/8V53.00	78770530	10	P	7	11 5/8	1138
QD10/8V30.00	78770300	10	N	5 7/8	11 5/8	463	QD12/8V53.00	78772530	12	W	8 1/2	13 7/8	1343
QD12/8V30.00	78772300	12	P	7	13 7/8	567	QD6/8V63.00	78766630	6	P	7	7 1/8	860
QD4/8V35.50	78764355	4	M	5 1/2	4 7/8	367	QD8/8V63.00	78768630	8	P	7	9 3/8	960
QD5/8V35.50	78765355	5	M	5 1/2	6	399	QD10/8V63.00	78770630	10	W	8 1/2	11 5/8	1143
QD6/8V35.50	78766355	6	N	5 7/8	7 1/8	444	QD12/8V63.00	78772630	12	W	8 1/2	13 7/8	1777
QD8/8V35.50	78768355	8	N	5 7/8	9 3/8	508	QD6/8V71.00	78766710	6	P	7	7 1/8	1558
QD10/8V35.50	78770355	10	P	7	11 5/8	605	QD8/8V71.00	78768710	8	W	8 1/2	9 3/8	1490
QD12/8V35.50	78772355	12	P	7	13 7/8	693	QD10/8V71.00	78770710	10	W	8 1/2	11 5/8	1881
QD4/8V40.00	78764400	4	M	5 1/2	4 7/8	434	QD12/8V71.00	78772710	12	W	8 1/2	13 7/8	2002

POLEAS HI-POWER® QD®

MERCADOS/APLICACIONES

Poleas para banda en V para secciones: HiPower®II, TriPower®, DobleV® y PowerBand®.

CARACTERÍSTICAS / VENTAJAS

- El deslizamiento completo de los bujes permite que su instalación y remoción sean fáciles.
- El diseño preciso de la polea produce una compresión positiva en la flecha.
- El diseño más angosto de la polea es manufacturado con precisión y balanceado estáticamente, para transmitir mayor potencia.

Notas: Las poleas que aplican para secciones múltiples aplican exclusivamente para secciones A y B. Los bujes se listan por separado.

CUIDADO: No se usen con bandas tipo PowerBand® "A". No se utilicen a velocidades superiores a 6,500 RPM.



(COMBINACIÓN DE SECCIONES A Ó B)

DESCRIPCIÓN	CÓDIGO	NO. RANURAS	DIÁM. MÁX. (PULG.)	BUJE	DIÁM. MÁX. BARRENO (PULG.)	ANCHO (PULG.)	PESO (LBS.)
QD1A3.0/B3.4	78311030	1	3.75	SH	1 5/8	7/8	2.3
QD2A3.0/B3.4	78312030	2	3.75	SH	1 5/8	1 3/4	3.39
QD3A3.0/B3.4	78313030	3	3.75	SH	1 5/8	2 1/2	4.38
QD4A3.0/B3.4	78314030	4	3.75	SD	1 15/16	3 1/4	4.73
QD5A3.0/B3.4	78315030	5	3.75	SD	1 15/16	4	5.25
QD6A3.0/B3.4	78316030	6	3.75	SD	1 15/16	4 3/4	5.95
QD1A3.2/B3.6	78311032	1	3.95	SH	1 5/8	7/8	3
QD2A3.2/B3.6	78312032	2	3.95	SH	1 5/8	1 3/4	2.63
QD3A3.2/B3.6	78313032	3	3.95	SH	1 5/8	2 1/2	3.48
QD4A3.2/B3.6	78314032	4	3.95	SD	1 15/16	3 1/4	5.14
QD5A3.2/B3.6	78315032	5	3.95	SD	1 15/16	4	5.9
QD6A3.2/B3.6	78316032	6	3.95	SD	1 15/16	4 3/4	6.76
QD1A3.4/B3.8	78311034	1	4.15	SH	1 5/8	7/8	1.62
QD2A3.4/B3.8	78312034	2	4.15	SH	1 5/8	1 3/4	2.95
QD3A3.4/B3.8	78313034	3	4.15	SH	1 5/8	2 1/2	4.01
QD4A3.4/B3.8	78314034	4	4.15	SD	1 15/16	3 1/4	6.32
QD5A3.4/B3.8	78315034	5	4.15	SD	1 15/16	4	6.41
QD6A3.4/B3.8	78316034	6	4.15	SD	1 15/16	4 3/4	7.25
QD1A3.6/B4.0	78311036	1	4.35	SH	1 5/8	7/8	1.86

(COMBINACIÓN DE SECCIONES A Ó B)

DESCRIPCIÓN	CÓDIGO	NO. RANURAS	DIÁM. MÁX. (PULG.)	BUJE	DIÁM. MÁX. BARRENO (PULG.)	ANCHO (PULG.)	PESO (LBS.)
QD2A3.6/B4.0	78312036	2	4.35	SH	1 5/8	1 3/4	3.2
QD3A3.6/B4.0	78313036	3	4.35	SH	1 5/8	2 1/2	4.18
QD4A3.6/B4.0	78314036	4	4.35	SD	1 15/16	3 1/4	5.54
QD5A3.6/B4.0	78315036	5	4.35	SD	1 15/16	4	6.58
QD6A3.6/B4.0	78316036	6	4.35	SD	1 15/16	4 3/4	6.94
QD1A3.8/B4.2	78311038	1	4.55	SH	1 5/8	7/8	2.13
QD2A3.8/B4.2	78312038	2	4.55	SH	1 5/8	1 3/4	3.57
QD3A3.8/B4.2	78313038	3	4.55	SH	1 5/8	2 1/2	4.76
QD4A3.8/B4.2	78314038	4	4.55	SD	1 15/16	3 1/4	6.33
QD5A3.8/B4.2	78315038	5	4.55	SD	1 15/16	4	7.53
QD6A3.8/B4.2	78316038	6	4.55	SD	1 15/16	4 3/4	8.71
QD1A4.0/B4.4	78311040	1	4.75	SH	1 5/8	7/8	2.42
QD2A4.0/B4.4	78312040	2	4.75	SH	1 5/8	1 3/4	3.88
QD3A4.0/B4.4	78313040	3	4.75	SH	1 5/8	2 1/2	5.01
QD4A4.0/B4.4	78314040	4	4.75	SD	1 15/16	3 1/4	6.74
QD5A4.0/B4.4	78315040	5	4.75	SD	1 15/16	4	6.62
QD6A4.0/B4.4	78316040	6	4.75	SD	1 15/16	4 3/4	9.13
QD1A4.2/B4.6	78311042	1	4.95	SDS	1 15/16	7/8	2.94
QD2A4.2/B4.6	78312042	2	4.95	SDS	1 15/16	1 3/4	4
QD3A4.2/B4.6	78313042	3	4.95	SD	1 15/16	2 1/2	5.89
QD4A4.2/B4.6	78314042	4	4.95	SD	1 15/16	3 1/4	7.13
QD5A4.2/B4.6	78315042	5	4.95	SD	1 15/16	4	8.3
QD6A4.2/B4.6	78316042	6	4.95	SD	1 15/16	4 3/4	9.51
QD1A4.4/B4.8	78311044	1	5.15	SDS	1 15/16	7/8	3.24
QD2A4.4/B4.8	78312044	2	5.15	SDS	1 15/16	1 3/4	4.31
QD3A4.4/B4.8	78313044	3	5.15	SD	1 15/16	2 1/2	6.32
QD4A4.4/B4.8	78314044	4	5.15	SD	1 15/16	3 1/4	7.61
QD5A4.4/B4.8	78315044	5	5.15	SD	1 15/16	4	8.92
QD6A4.4/B4.8	78316044	6	5.15	SD	1 15/16	4 3/4	10.16
QD1A4.6/B5.0	78311046	1	5.35	SDS	1 15/16	7/8	3.62
QD2A4.6/B5.0	78312046	2	5.35	SDS	1 15/16	1 3/4	5
QD3A4.6/B5.0	78313046	3	5.35	SD	1 15/16	2 1/2	6.92
QD4A4.6/B5.0	78314046	4	5.35	SD	1 15/16	3 1/4	8.24
QD5A4.6/B5.0	78315046	5	5.35	SD	1 15/16	4	9.68
QD6A4.6/B5.0	78316046	6	5.35	SD	1 15/16	4 3/4	10.99
QD1A4.8/B5.2	78311048	1	5.55	SDS	1 15/16	7/8	4
QD2A4.8/B5.2	78312048	2	5.55	SDS	1 15/16	1 3/4	5.33
QD3A4.8/B5.2	78313048	3	5.55	SD	1 15/16	2 1/2	7.96
QD4A4.8/B5.2	78314048	4	5.55	SD	1 15/16	3 1/4	9.63
QD5A4.8/B5.2	78315048	5	5.55	SD	1 15/16	4	11.19
QD6A4.8/B5.2	78316048	6	5.55	SD	1 15/16	4 3/4	12.82
QD1A5.0/B5.4	78311050	1	5.75	SDS	1 15/16	7/8	4.47
QD2A5.0/B5.4	78312050	2	5.75	SDS	1 15/16	1 3/4	5.85
QD3A5.0/B5.4	78313050	3	5.75	SD	1 15/16	2 1/2	8.31

(COMBINACIÓN DE SECCIONES A Ó B)

DESCRIPCIÓN	CÓDIGO	NO. RANURAS	DIÁM. MÁX. (PULG.)	BUJE	DIÁM. MÁX. BARRENO (PULG.)	ANCHO (PULG.)	PESO (LBS.)
QD4A5.0/B5.4	78314050	4	5.75	SD	1 15/16	3 1/4	9.98
QD5A5.0/B5.4	78315050	5	5.75	SK	2 1/2	4	10.45
QD6A5.0/B5.4	78316050	6	5.75	SK	2 1/2	4 3/4	11.56
QD7A5.0/B5.4	78317050	7	5.75	SK	2 1/2	5 1/2	12.6
QD8B5.4	78328054	8	5.75	SK	2 1/2	6 1/4	13.3
QD10B5.4	78330054	10	5.75	SK	2 1/2	7 3/4	17.06
QD1A5.2/B5.6	78311052	1	5.95	SDS	1 15/16	7/8	4.59
QD2A5.2/B5.6	78312052	2	5.95	SDS	1 15/16	1 3/4	6.01
QD3A5.2/B5.6	78313052	3	5.95	SD	1 15/16	2 1/2	9.41
QD4A5.2/B5.6	78314052	4	5.95	SD	1 15/16	3 1/4	11.38
QD5A5.2/B5.6	78315052	5	5.95	SK	2 1/2	4	11.02
QD6A5.2/B5.6	78316052	6	5.95	SK	2 1/2	4 3/4	12.62
QD7A5.2/B5.6	78317052	7	5.95	SK	2 1/2	5 1/2	14
QD8B5.6	78328056	8	5.95	SK	2 1/2	6 1/4	16.82
QD10B5.6	78330056	10	5.95	SK	2 1/2	7 3/4	18.87
QD1A5.4/B5.8	78311054	1	6.15	SDS	1 15/16	7/8	4.8
QD2A5.4/B5.8	78312054	2	6.15	SDS	1 15/16	1 3/4	6.57
QD3A5.4/B5.8	78313054	3	6.15	SD	1 15/16	2 1/2	9.65
QD4A5.4/B5.8	78314054	4	6.15	SD	1 15/16	3 1/4	11.36
QD5A5.4/B5.8	78315054	5	6.15	SK	2 1/2	4	12.45
QD6A5.4/B5.8	78316054	6	6.15	SK	2 1/2	4 3/4	14.16
QD7A5.4/B5.8	78317054	7	6.15	SK	2 1/2	5 1/2	15.1
QD8B5.8	78328058	8	6.15	SK	2 1/2	6 1/4	16.6
QD10B5.8	78330058	10	6.15	SK	2 1/2	7 3/4	18.87
QD1A5.4/B5.8	78311054	1	6.15	SDS	1 15/16	7/8	4.8
QD2A5.4/B5.8	78312054	2	6.15	SDS	1 15/16	1 3/4	6.57
QD3A5.4/B5.8	78313054	3	6.15	SD	1 15/16	2 1/2	9.65
QD4A5.4/B5.8	78314054	4	6.15	SD	1 15/16	3 1/4	11.36
QD5A5.4/B5.8	78315054	5	6.15	SK	2 1/2	4	12.45
QD6A5.4/B5.8	78316054	6	6.15	SK	2 1/2	4 3/4	14.16
QD7A5.4/B5.8	78317054	7	6.15	SK	2 1/2	5 1/2	15.1
QD8B5.8	78328058	8	6.15	SK	2 1/2	6 1/4	16.6
QD10B5.8	78330058	10	6.15	SK	2 1/2	7 3/4	19.8
QD1A5.6/B6.0	78311056	1	6.35	SDS	1 15/16	7/8	5.23
QD2A5.6/B6.0	78312056	2	6.35	SDS	1 15/16	1 3/4	7.12
QD3A5.6/B6.0	78313056	3	6.35	SD	1 15/16	2 1/2	10.78
QD4A5.6/B6.0	78314056	4	6.35	SD	1 15/16	3 1/4	12.8
QD5A5.6/B6.0	78315056	5	6.35	SK	2 1/2	4	12.78
QD6A5.6/B6.0	78316056	6	6.35	SK	2 1/2	4 3/4	15.12
QD7A5.6/B6.0	78317056	7	6.35	SF	2 15/16	5 1/2	15.2
QD8B6.0	78328060	8	6.35	SF	2 15/16	6 1/4	15.98
QD10B6.0	78330060	10	6.35	SF	2 15/16	7 3/4	16.79
QD1A5.8/B6.2	78311058	1	6.55	SDS	1 15/16	7/8	5.7
QD2A5.8/B6.2	78312058	2	6.55	SDS	1 15/16	1 3/4	7.95

(COMBINACIÓN DE SECCIONES A Ó B)

DESCRIPCIÓN	CÓDIGO	NO. RANURAS	DIÁM. MÁX. (PULG.)	BUJE	DIÁM. MÁX. BARRENO (PULG.)	ANCHO (PULG.)	PESO (LBS.)
QD3A5.8/B6.2	78313058	3	6.55	SD	1 15/16	2 1/2	12.02
QD4A5.8/B6.2	78314058	4	6.55	SD	1 15/16	3 1/4	14.03
QD5A5.8/B6.2	78315058	5	6.55	SK	2 1/2	4	14.1
QD6A5.8/B6.2	78316058	6	6.55	SK	2 1/2	4 3/4	16.05
QD7A5.8/B6.2	78317058	7	6.55	SF	2 15/16	5 1/2	16.7
QD8B6.2	78328062	8	6.55	SF	2 15/16	6 1/4	18.4
QD10B6.2	78330062	10	6.55	SF	2 15/16	7 3/4	22
QD1A6.0/B6.4	78311060	1	6.75	SDS	1 15/16	7/8	5.94
QD2A6.0/B6.4	78312060	2	6.75	SDS	1 15/16	1 3/4	7.92
QD3A6.0/B6.4	78313060	3	6.75	SD	1 15/16	2 1/2	11.73
QD4A6.0/B6.4	78314060	4	6.75	SD	1 15/16	3 1/4	13.65
QD5A6.0/B6.4	78315060	5	6.75	SK	2 1/2	4	16.76
QD6A6.0/B6.4	78316060	6	6.75	SK	2 1/2	4 3/4	15.7
QD7A6.0/B6.4	78317060	7	6.75	SF	2 15/16	5 1/2	17.2
QD8B6.4	78328064	8	6.75	SF	2 15/16	6 1/4	19.66
QD10B6.4	78330064	10	6.75	SF	2 15/16	7 3/4	25.16
QD1A6.2/B6.6	78311062	1	6.95	SDS	1 15/16	7/8	6.44
QD2A6.2/B6.6	78312062	2	6.95	SDS	1 15/16	1 3/4	9
QD3A6.2/B6.6	78313062	3	6.95	SD	1 15/16	2 1/2	13.5
QD4A6.2/B6.6	78314062	4	6.95	SD	1 15/16	3 1/4	15.28
QD5A6.2/B6.6	78315062	5	6.95	SK	2 1/2	4	16.04
QD6A6.2/B6.6	78316062	6	6.95	SK	2 1/2	4 3/4	20.88
QD7A6.2/B6.6	78317062	7	6.95	SF	2 15/16	5 1/2	18.3
QD8B6.6	78328066	8	6.95	SF	2 15/16	6 1/4	20
QD10B6.6	78330066	10	6.95	SF	2 15/16	7 3/4	24
QD1A6.4/B6.8	78311064	1	7.15	SDS	1 15/16	7/8	7
QD2A6.4/B6.8	78312064	2	7.15	SDS	1 15/16	1 3/4	9.71
QD3A6.4/B6.8	78313064	3	7.15	SD	1 15/16	2 1/2	14.33
QD4A6.4/B6.8	78314064	4	7.15	SD	1 15/16	3 1/4	16.95
QD5A6.4/B6.8	78315064	5	7.15	SK	2 1/2	4	18.18
QD6A6.4/B6.8	78316064	6	7.15	SK	2 1/2	4 3/4	23.28
QD7A6.4/B6.8	78317064	7	7.15	SF	2 15/16	5 1/2	19.5
QD8B6.8	78328068	8	7.15	SF	2 15/16	6 1/4	24.33
QD10B6.8	78330068	10	7.15	SF	2 15/16	7 3/4	24.4
QD1A6.6/B7.0	78311066	1	7.35	SDS	1 15/16	7/8	7
QD2A6.6/B7.0	78312066	2	7.35	SK	2 1/2	1 3/4	11.21
QD3A6.6/B7.0	78313066	3	7.35	SK	2 1/2	2 1/2	13.02
QD4A6.6/B7.0	78314066	4	7.35	SK	2 1/2	3 1/4	16.33
QD5A6.6/B7.0	78315066	5	7.35	SF	2 15/16	4	16.84
QD6A6.6/B7.0	78316066	6	7.35	SF	2 15/16	4 3/4	18.75
QD7A6.6/B7.0	78317066	7	7.35	SF	2 15/16	5 1/2	21
QD8B7.0	78328070	8	7.35	SF	2 15/16	6 1/4	23
QD10B7.0	78330070	10	7.35	SF	2 15/16	7 3/4	27
QD1A7.0/B7.4	78311070	1	7.75	SDS	1 15/16	1	8.29

(COMBINACIÓN DE SECCIONES A Ó B)

DESCRIPCIÓN	CÓDIGO	NO. RANURAS	DIÁM. MÁX. (PULG.)	BUJE	DIÁM. MÁX. BARRENO (PULG.)	ANCHO (PULG.)	PESO (LBS.)
QD2A7.0/B7.4	78312070	2	7.75	SK	2 1/2	1 3/4	13.12
QD3A7.0/B7.4	78313070	3	7.75	SK	2 1/2	2 1/2	15.17
QD4A7.0/B7.4	78314070	4	7.75	SK	2 1/2	3 1/4	18.21
QD5A7.0/B7.4	78315070	5	7.75	SF	2 15/16	4	21.39
QD6A7.0/B7.4	78316070	6	7.75	SF	2 15/16	4 3/4	20.89
QD7A7.0/B7.4	78317070	7	7.75	SF	2 15/16	5 1/2	23
QD8B7.4	78328074	8	7.75	SF	2 15/16	6 1/4	34.14
QD10B7.4	78330074	10	7.75	SF	2 15/16	7 3/4	30
QD1A7.6/B8.0	78311076	1	8.35	SDS	1 15/16	1	9.77
QD2A7.6/B8.0	78312076	2	8.35	SK	2 1/2	1 3/4	12.53
QD3A7.6/B8.0	78313076	3	8.35	SK	2 1/2	2 1/2	17.46
QD4A7.6/B8.0	78314076	4	8.35	SK	2 1/2	3 1/4	20.83
QD5A7.6/B8.0	78315076	5	8.35	SF	2 15/16	4	22.14
QD6A7.6/B8.0	78316076	6	8.35	SF	2 15/16	4 3/4	23.94
QD1A8.2/B8.6	78311082	1	8.95	SDS	1 15/16	1	10.83
QD2A8.2/B8.6	78312082	2	8.95	SK	2 1/2	1 3/4	15.65
QD3A8.2/B8.6	78313082	3	8.95	SK	2 1/2	2 1/2	22.12
QD4A8.2/B8.6	78314082	4	8.95	SK	2 1/2	3 1/4	25.65
QD5A8.2/B8.6	78315082	5	8.95	SF	2 15/16	4	24.95
QD6A8.2/B8.6	78316082	6	8.95	SF	2 15/16	4 3/4	27.46
QD7A8.2/B8.6	78317082	7	8.95	E	3 1/2	5 1/2	31
QD8B8.6	78328086	8	8.95	E	3 1/2	6 1/4	33.57
QD10B8.6	78330086	10	8.95	E	3 1/2	7 3/4	55.52
QD1A9.0/B9.4	78311090	1	9.75	SDS	1 15/16	1	12.8
QD2A9.0/B9.4	78312090	2	9.75	SK	2 1/2	1 3/4	16.35
QD3A9.0/B9.4	78313090	3	9.75	SK	2 1/2	2 1/2	19.58
QD4A9.0/B9.4	78314090	4	9.75	SK	2 1/2	3 1/4	24.66
QD5A9.0/B9.4	78315090	5	9.75	SF	2 15/16	4	29.53
QD6A9.0/B9.4	78316090	6	9.75	SF	2 15/16	4 3/4	34.13
QD7A9.0/B9.4	78317090	7	9.75	E	3 1/2	5 1/2	33
QD8B9.4	78328094	8	9.75	E	3 1/2	6 1/4	51
QD10B9.4	78330094	10	9.75	E	3 1/2	7 3/4	60.7
QD1A10.6/B11.0	78311106	1	11.35	SDS	1 15/16	1	12.76
QD2A10.6/B11.0	78312106	2	11.35	SK	2 1/2	1 3/4	19.79
QD3A10.6/B11.0	78313106	3	11.35	SK	2 1/2	2 1/2	19.8
QD4A10.6/B11.0	78314106	4	11.35	SK	2 1/2	3 1/4	24.75
QD5A10.6/B11.0	78315106	5	11.35	SF	2 15/16	4	34.15
QD6A10.6/B11.0	78316106	6	11.35	SF	2 15/16	4 3/4	36
QD7A10.6/B11.0	78317106	7	11.35	E	3 1/2	5 1/2	42
QD8B11.0	78328110	8	11.35	E	3 1/2	6 1/4	60.3
QD10B11.0	78330110	10	11.35	E	3 1/2	7 3/4	69.48
QD1A12.0/B12.4	78311120	1	12.75	SDS	1 15/16	1	13.79
QD2A12.0/B12.4	78312120	2	12.75	SK	2 1/2	1 3/4	19.52

(COMBINACIÓN DE SECCIONES A Ó B)

DESCRIPCIÓN	CÓDIGO	NO. RANURAS	DIÁM. MÁX. (PULG.)	BUJE	DIÁM. MÁX. BARRENO (PULG.)	ANCHO (PULG.)	PESO (LBS.)
QD3A12.0/B12.4	78313120	3	12.75	SK	2 1/2	2 1/2	23.34
QD4A12.0/B12.4	78314120	4	12.75	SK	2 1/2	3 1/4	28.48
QD5A12.0/B12.4	78315120	5	12.75	SF	2 15/16	4	36.32
QD6A12.0/B12.4	78316120	6	12.75	SF	2 15/16	4 3/4	43.74
QD7A12.0/B12.4	78317120	7	12.75	E	3 1/2	5 1/2	48
QD8B12.4	78328124	8	12.75	E	3 1/2	6 1/4	54.38
QD10B12.4	78330124	10	12.75	F	3 15/16	7 3/4	113.2
QD1A13.2/B13.6	78311132	1	13.95	SDS	1 15/16	1	17.15
QD2A13.2/B13.6	78312132	2	13.95	SK	2 1/2	1 3/4	25.56
QD3A13.2/B13.6	78313132	3	13.95	SK	2 1/2	2 1/2	29.31
QD4A13.2/B13.6	78314132	4	13.95	SK	2 1/2	3 1/4	34.47
QD5A13.2/B13.6	78315132	5	13.95	SF	2 15/16	4	47.92
QD6A13.2/B13.6	78316132	6	13.95	SF	2 15/16	4 3/4	52.46
QD7A13.2/B13.6	78317132	7	13.95	E	3 1/2	5 1/2	49
QD8B13.6	78328136	8	13.95	E	3 1/2	6 1/4	53
QD10B13.6	78330136	10	13.95	F	3 15/16	7 3/4	73
QD1A15.0/B15.4	78311150	1	15.75	SK	2 1/2	1	20.93
QD2A15.0/B15.4	78312150	2	15.75	SK	2 1/2	1 3/4	25.32
QD3A15.0/B15.4	78313150	3	15.75	SK	2 1/2	2 1/2	41.5
QD4A15.0/B15.4	78314150	4	15.75	SF	2 15/16	3 1/4	45.74
QD5A15.0/B15.4	78315150	5	15.75	SF	2 15/16	4	49
QD6A15.0/B15.4	78316150	6	15.75	SF	2 15/16	4 3/4	66.41
QD7A15.0/B15.4	78317150	7	15.75	E	3 1/2	5 1/2	62
QD8B15.4	78328154	8	15.75	E	3 1/2	6 1/4	82.26
QD10B15.4	78330154	10	15.75	F	3 15/16	7 3/4	98.5
QD1A15.6/B16.0	78311156	1	16.35	SK	2 1/2	1	24.87
QD2A15.6/B16.0	78312156	2	16.35	SK	2 1/2	1 3/4	32.83
QD3A15.6/B16.0	78313156	3	16.35	SK	2 1/2	2 1/2	50.72
QD4A15.6/B16.0	78314156	4	16.35	SF	2 15/16	3 1/4	56.03
QD5A15.6/B16.0	78315156	5	16.35	SF	2 15/16	4	75
QD6A15.6/B16.0	78316156	6	16.35	SF	2 15/16	4 3/4	81.85
QD7A15.6/B16.0	78317156	7	16.35	E	3 1/2	5 1/2	69
QD8B16.0	78328160	8	16.35	E	3 1/2	6 1/4	73
QD10B16.0	78330160	10	16.35	F	3 15/16	7 3/4	95
QD1A18.0/B18.4	78311180	1	18.75	SK	2 1/2	1	50.18
QD2A18.0/B18.4	78312180	2	18.75	SK	2 1/2	1 3/4	39.8
QD3A18.0/B18.4	78313180	3	18.75	SK	2 1/2	2 1/2	45.85
QD4A18.0/B18.4	78314180	4	18.75	SF	2 15/16	3 1/4	63.31
QD5A18.0/B18.4	78315180	5	18.75	SF	2 15/16	4	70.36
QD6A18.0/B18.4	78316180	6	18.75	SF	2 15/16	4 3/4	73
QD7A18.0/B18.4	78317180	7	18.75	F	3 15/16	5 1/2	80
QD8B18.4	78328184	8	18.75	F	3 15/16	6 1/4	87.7
QD10B18.4	78330184	10	18.75	F	3 15/16	7 3/4	116
QD1A19.6/B20.0	78321200	1	20.35	SK	2 1/2	1	30.31

(COMBINACIÓN DE SECCIONES A Ó B)

DESCRIPCIÓN	CÓDIGO	NO. RANURAS	DIÁM. MÁX. (PULG.)	BUJE	DIÁM. MÁX. BARRENO (PULG.)	ANCHO (PULG.)	PESO (LBS.)
QD2A19.6/B20.0	78322200	2	20.35	SF	2 15/16	1 3/4	41.34
QD3A19.6/B20.0	78323200	3	20.35	SF	2 15/16	2 1/2	43.2
QD4A19.6/B20.0	78324200	4	20.35	SF	2 15/16	3 3/4	58
QD5A19.6/B20.0	78325200	5	20.35	E	3 1/2	4	74
QD6A19.6/B20.0	78326200	6	20.35	E	3 1/2	4 3/4	82
QD7A19.6/B20.0	78327200	7	20.35	F	3 15/16	5 1/2	95
QD8B20.0	78328200	8	20.35	F	3 15/16	6 1/4	87
QD10B20.0	78330200	10	20.35	F	3 15/16	7 3/4	110
QD1A24.6/B25.0	78321250	1	25.35	SF	2 15/16	1	40
QD2A24.6/B25.0	78322250	2	25.35	SF	2 15/16	1 3/4	58
QD3A24.6/B25.0	78323250	3	25.35	SF	2 15/16	2 1/2	73
QD4A24.6/B25.0	78324250	4	25.35	E	3 1/2	3 1/4	77
QD5A24.6/B25.0	78325250	5	25.35	E	3 1/2	4	97.33
QD6A24.6/B25.0	78326250	6	25.35	E	3 1/2	4 3/4	116
QD7A24.6/B25.0	78327250	7	25.35	F	3 15/16	5 1/2	123
QD8B25.0	78328250	8	25.35	F	3 15/16	6 1/4	118
QD1A29.6/B30.0	78321300	1	30.35	SF	2 15/16	1	52
QD2A29.6/B30.0	78322300	2	30.35	SF	2 15/16	1 3/4	72
QD3A29.6/B30.0	78323300	3	30.35	SF	2 15/16	2 1/2	83
QD4A29.6/B30.0	78324300	4	30.35	E	3 1/2	3 1/4	110
QD5A29.6/B30.0	78325300	5	30.35	E	3 1/2	4	105
QD6A29.6/B30.0	78326300	6	30.35	E	3 1/2	4 3/4	132
QD7A29.6/B30.0	78327300	7	30.35	F	3 15/16	5 1/2	160
QD8B30.0	78328300	8	30.35	F	3 15/16	6 1/4	149
QD10B30.0	78330300	10	30.35	F	3 15/16	7 3/4	165
QD2A37.6/B38.0	78322380	2	38.35	SF	2 15/16	1 3/4	165
QD3A37.6/B38.0	78323380	3	38.35	E	3 1/2	2 1/2	103
QD4A37.6/B38.0	78324380	4	38.35	E	3 1/2	3 1/4	120
QD5A37.6/B38.0	78325380	5	38.35	E	3 1/2	4	145
QD6A37.6/B38.0	78326380	6	38.35	E	3 1/2	4 3/4	175
QD7A37.6/B38.0	78327380	7	38.35	F	3 15/16	5 1/2	233
QD8B38.0	78328380	8	38.35	F	3 15/16	6 1/4	205
QD10B38.0	78330380	10	38.35	J	4 1/2	7 3/4	230
QD3C5.0	78343050	3	5.40	SD	1 15/16	3 3/8	8.55
QD4C5.0	78344050	4	5.40	SD	1 15/16	4 3/8	10.42
QD2C5.6	78342056	2	6.00	SD	1 15/16	2 3/8	8.5
QD3C5.6	78343056	3	6.00	SD	1 15/16	3 3/8	11.5
QD4C5.6	78344056	4	6.00	SD	1 15/16	4 3/8	13.3
QD3C6.0	78343060	3	6.40	SF	2 15/16	3 3/8	11.5
QD4C6.0	78344060	4	6.40	SF	2 15/16	4 3/8	13.9
QD5C6.0	78345060	5	6.40	SF	2 15/16	5 3/8	16.3
QD6C6.0	78346060	6	6.40	SF	2 15/16	6 3/8	18.6
QD1C7.0	78341070	1	7.40	SF	2 15/16	1 3/8	9.5
QD2C7.0	78342070	2	7.40	SF	2 15/16	2 3/8	12.4

(COMBINACIÓN DE SECCIONES A Ó B)

DESCRIPCIÓN	CÓDIGO	NO. RANURAS	DIÁM. MÁX. (PULG.)	BUJE	DIÁM. MÁX. BARRENO (PULG.)	ANCHO (PULG.)	PESO (LBS.)
QD3C7.0	78343070	3	7.40	SF	2 15/16	3 3/8	14.97
QD4C7.0	78344070	4	7.40	SF	2 15/16	4 3/8	17.84
QD5C7.0	78345070	5	7.40	SF	2 15/16	5 3/8	22.67
QD6C7.0	78346070	6	7.40	SF	2 15/16	6 3/8	24.1
QD7C7.0	78347070	7	7.40	SF	2 15/16	7 3/8	26
QD8C7.0	78348070	8	7.40	SF	2 15/16	8 3/8	29.81
QD1C7.5	78341075	1	7.90	SF	2 15/16	1 3/8	11.38
QD2C7.5	78342075	2	7.90	SF	2 15/16	2 3/8	14.86
QD3C7.5	78343075	3	7.90	SF	2 15/16	3 3/8	17.28
QD4C7.5	78344075	4	7.90	SF	2 15/16	4 3/8	21.09
QD5C7.5	78345075	5	7.90	SF	2 15/16	5 3/8	29.94

SECCIÓN C

DESCRIPCIÓN	CÓDIGO	NO. RANURAS	DIÁM. MÁX. (PULG.)	BUJE	DIÁM. MÁX. BARRENO (PULG.)	ANCHO (PULG.)	PESO (LBS.)
QD6C7.5	78346075	6	7.9	SF	2 15/16	6 3/8	33.61
QD1C8.0	78341080	1	8.4	SF	2 15/16	1 3/8	13.23
QD2C8.0	78342080	2	8.4	SF	2 15/16	2 3/8	16.62
QD3C8.0	78343080	3	8.4	E	3 1/2	3 3/8	20.35
QD4C8.0	78344080	4	8.4	E	3 1/2	4 3/8	24.12
QD5C8.0	78345080	5	8.4	E	3 1/2	5 3/8	27.26
QD6C8.0	78346080	6	8.4	E	3 1/2	6 3/8	32.32
QD7C8.0	78347080	7	8.4	E	3 1/2	7 3/8	35
QD8C8.0	78348080	8	8.4	E	3 1/2	8 3/8	37.52
QD9C8.0	78349080	9	8.4	E	3 1/2	9 3/8	42
QD10C8.0	78350080	10	8.4	E	3 1/2	10 3/8	44.7
QD1C8.5	78341085	1	8.9	SF	2 15/16	1 3/8	15.38
QD2C8.5	78342085	2	8.9	SF	2 15/16	2 3/8	18.97
QD3C8.5	78343085	3	8.9	E	3 1/2	3 3/8	23.41
QD4C8.5	78344085	4	8.9	E	3 1/2	4 3/8	26.77
QD5C8.5	78345085	5	8.9	E	3 1/2	5 3/8	37
QD6C8.5	78346085	6	8.9	E	3 1/2	6 3/8	42.47
QD7C8.5	78347085	7	8.9	E	3 1/2	7 3/8	40
QD8C8.5	78348085	8	8.9	E	3 1/2	8 3/8	46.38
QD9C8.5	78349085	9	8.9	E	3 1/2	9 3/8	47
QD10C8.5	78350085	10	8.9	E	3 1/2	10 3/8	50.58
QD1C9.0	78341090	1	9.4	SF	2 15/16	1 3/8	17.77
QD2C9.0	78342090	2	9.4	SF	2 15/16	2 3/8	22.2
QD3C9.0	78343090	3	9.4	E	3 1/2	3 3/8	26.55
QD4C9.0	78344090	4	9.4	E	3 1/2	4 3/8	30.63
QD5C9.0	78345090	5	9.4	E	3 1/2	5 3/8	35
QD6C9.0	78346090	6	9.4	F	3 15/16	6 3/8	42.31
QD7C9.0	78347090	7	9.4	F	3 15/16	7 3/8	48

SECCIÓN C

DESCRIPCIÓN	CÓDIGO	NO. RANURAS	DIÁM. MÁX. (PULG.)	BUJE	DIÁM. MÁX. BARRENO (PULG.)	ANCHO (PULG.)	PESO (LBS.)
QD8C9.0	78348090	8	9.4	F	3 15/16	8 3/8	50.07
QD9C9.0	78349090	9	9.4	J	4 1/2	9 3/8	51
QD10C9.0	78350090	10	9.4	J	4 1/2	10 3/8	101
QD12C9.0	78352090	12	9.4	J	4 1/2	12 3/8	75
QD1C9.5	78341095	1	9.9	SF	2 15/16	1 3/8	19.84
QD2C9.5	78342095	2	9.9	SF	2 15/16	2 3/8	23.99
QD3C9.5	78343095	3	9.9	E	3 1/2	3 3/8	30.05
QD4C9.5	78344095	4	9.9	E	3 1/2	4 3/8	34.3
QD5C9.5	78345095	5	9.9	E	3 1/2	5 3/8	44.18
QD6C9.5	78346095	6	9.9	F	3 15/16	6 3/8	53.68
QD7C9.5	78347095	7	9.9	F	3 15/16	7 3/8	55
QD8C9.5	78348095	8	9.9	F	3 15/16	8 3/8	56.13
QD9C9.5	78349095	9	9.9	J	4 1/2	9 3/8	66
QD10C9.5	78350095	10	9.9	J	4 1/2	10 3/8	101
QD12C9.5	78352095	12	9.9	J	4 1/2	12 3/8	86
QD1C10.0	78341100	1	10.4	SF	2 15/16	1 3/8	17.58
QD2C10.0	78342100	2	10.4	SF	2 15/16	2 3/8	21.7
QD3C10.0	78343100	3	10.4	E	3 1/2	3 3/8	33.7
QD4C10.0	78344100	4	10.4	E	3 1/2	4 3/8	38.09
QD5C10.0	78345100	5	10.4	E	3 1/2	5 3/8	42.67
QD6C10.0	78346100	6	10.4	F	3 15/16	6 3/8	54.19
QD7C10.0	78347100	7	10.4	F	3 15/16	7 3/8	60
QD8C10.0	78348100	8	10.4	F	3 15/16	8 3/8	72.71
QD9C10.0	78349100	9	10.4	J	4 1/2	9 3/8	72
QD10C10.0	78350100	10	10.4	J	4 1/2	10 3/8	70.62
QD12C10.0	78352100	12	10.4	J	4 1/2	12 3/8	86
QD1C10.5	78341105	1	10.9	SF	2 15/16	1 3/8	18.45
QD2C10.5	78342105	2	10.9	SF	2 15/16	2 3/8	23.2
P	78343105	3	10.9	E	3 1/2	3 3/8	37.99
QD4C10.5	78344105	4	10.9	E	3 1/2	4 3/8	42.98
QD5C10.5	78345105	5	10.9	E	3 1/2	5 3/8	42
QD6C10.5	78346105	6	10.9	F	3 15/16	6 3/8	66.75
QD7C10.5	78347105	7	10.9	F	3 15/16	7 3/8	66
QD8C10.5	78348105	8	10.9	F	3 15/16	8 3/8	90
QD9C10.5	78349105	9	10.9	J	4 1/2	9 3/8	80
QD10C10.5	78350105	10	10.9	J	4 1/2	10 3/8	101
QD12C10.5	78352105	12	10.9	J	4 1/2	12 3/8	96
QD1C11.0	78341110	1	11.4	SF	2 15/16	1 3/8	22.22
QD2C11.0	78342110	2	11.4	SF	2 15/16	2 3/8	24.57
QD3C11.0	78343110	3	11.4	E	3 1/2	3 3/8	31.37
QD4C11.0	78344110	4	11.4	E	3 1/2	4 3/8	46.44
QD5C11.0	78345110	5	11.4	E	3 1/2	5 3/8	51.83
QD6C11.0	78346110	6	11.4	F	3 15/16	6 3/8	65.65
QD7C11.0	78347110	7	11.4	F	3 15/16	7 3/8	73

SECCIÓN C

DESCRIPCIÓN	CÓDIGO	NO. RANURAS	DIÁM. MÁX. (PULG.)	BUJE	DIÁM. MÁX. BARRENO (PULG.)	ANCHO (PULG.)	PESO (LBS.)
QD8C11.0	78348110	8	11.4	F	3 15/16	8 3/8	75.99
QD9C11.0	78349110	9	11.4	J	4 1/2	9 3/8	88
QD10C11.0	78350110	10	11.4	J	4 1/2	10 3/8	86
QD12C11.0	78352110	12	11.4	J	4 1/2	12 3/8	104
QD1C12.0	78341120	1	12.4	SF	2 15/16	1 3/8	22.01
QD2C12.0	78342120	2	12.4	SF	2 15/16	2 3/8	27.01
QD3C12.0	78343120	3	12.4	E	3 1/2	3 3/8	41.06
QD4C12.0	78344120	4	12.4	E	3 1/2	4 3/8	48.45
QD5C12.0	78345120	5	12.4	E	3 1/2	5 3/8	75.78
QD6C12.0	78346120	6	12.4	F	3 15/16	6 3/8	95.7
QD7C12.0	78347120	7	12.4	F	3 15/16	7 3/8	70
QD8C12.0	78348120	8	12.4	F	3 15/16	8 3/8	34.52
QD9C12.0	78349120	9	12.4	J	4 1/2	9 3/8	102
QD10C12.0	78350120	10	12.4	J	4 1/2	10 3/8	151
QD12C12.0	78352120	12	12.4	J	4 1/2	12 3/8	126
QD1C13.0	78341130	1	13.4	SF	2 15/16	1 3/8	24.56
QD2C13.0	78342130	2	13.4	SF	2 15/16	2 3/8	30.39
QD3C13.0	78343130	3	13.4	E	3 1/2	3 3/8	41.45
QD4C13.0	78344130	4	13.4	E	3 1/2	4 3/8	50.55
QD5C13.0	78345130	5	13.4	E	3 1/2	5 3/8	60.62
QD6C13.0	78346130	6	13.4	F	3 15/16	6 3/8	72.5
QD7C13.0	78347130	7	13.4	F	3 15/16	7 3/8	78
QD8C13.0	78348130	8	13.4	F	3 15/16	8 3/8	108
QD9C13.0	78349130	9	13.4	J	4 1/2	9 3/8	99
QD10C13.0	78350130	10	13.4	J	4 1/2	10 3/8	120
QD12C13.0	78352130	12	13.4	J	4 1/2	12 3/8	134
QD1C14.0	78341140	1	14.4	SF	2 15/16	1 3/8	27.38
QD2C14.0	78342140	2	14.4	SF	2 15/16	2 3/8	33.66
QD3C14.0	78343140	3	14.4	E	3 1/2	3 3/8	50.07
QD4C14.0	78344140	4	14.4	E	3 1/2	4 3/8	54.45
QD5C14.0	78345140	5	14.4	E	3 1/2	5 3/8	68
QD6C14.0	78346140	6	14.4	F	3 15/16	6 3/8	84
QD7C14.0	78347140	7	14.4	F	3 15/16	7 3/8	84
QD8C14.0	78348140	8	14.4	F	3 15/16	8 3/8	144.5
QD9C14.0	78349140	9	14.4	J	4 1/2	9 3/8	108
QD10C14.0	78350140	10	14.4	J	4 1/2	10 3/8	181
QD12C14.0	78352140	12	14.4	J	4 1/2	12 3/8	153
QD1C16.0	78341160	1	16.4	SF	2 15/16	1 3/8	33.76
QD2C16.0	78342160	2	16.4	SF	2 15/16	2 3/8	41.28
QD3C16.0	78343160	3	16.4	E	3 1/2	3 3/8	52.88
QD4C16.0	78344160	4	16.4	E	3 1/2	4 3/8	62.88
QD5C16.0	78345160	5	16.4	E	3 1/2	5 3/8	79
QD6C16.0	78346160	6	16.4	F	3 15/16	6 3/8	92
QD7C16.0	78347160	7	16.4	F	3 15/16	7 3/8	100

SECCIÓN C

DESCRIPCIÓN	CÓDIGO	NO. RANURAS	DIÁM. MÁX. (PULG.)	BUJE	DIÁM. MÁX. BARRENO (PULG.)	ANCHO (PULG.)	PESO (LBS.)
QD8C16.0	78348160	8	16.4	F	3 15/16	8 3/8	125.3
QD9C16.0	78349160	9	16.4	J	4 1/2	9 3/8	129
QD10C16.0	78350160	10	16.4	J	4 1/2	10 3/8	237
QD12C16.0	78352160	12	16.4	J	4 1/2	12 3/8	175
QD1C18.0	78341180	1	18.4	SF	2 15/16	1 3/8	44.5
QD2C18.0	78342180	2	18.4	SF	2 15/16	2 3/8	56.16
QD3C18.0	78343180	3	18.4	E	3 1/2	3 3/8	65.99
QD4C18.0	78344180	4	18.4	E	3 1/2	4 3/8	85.01
QD5C18.0	78345180	5	18.4	E	3 1/2	5 3/8	96.28
QD6C18.0	78346180	6	18.4	F	3 15/16	6 3/8	126
QD7C18.0	78347180	7	18.4	F	3 15/16	7 3/8	117
QD8C18.0	78348180	8	18.4	F	3 15/16	8 3/8	133
QD9C18.0	78349180	9	18.4	J	4 1/2	9 3/8	143
QD10C18.0	78350180	10	18.4	J	4 1/2	10 3/8	249
QD12C18.0	78352180	12	18.4	J	4 1/2	12 3/8	198
QD1C20.0	78341200	1	20.4	SF	2 15/16	1 3/8	31.69
QD2C20.0	78342200	2	20.4	SF	2 15/16	2 3/8	54.1
QD3C20.0	78343200	3	20.4	E	3 1/2	3 3/8	69
QD4C20.0	78344200	4	20.4	E	3 1/2	4 3/8	86
QD5C20.0	78345200	5	20.4	F	3 15/16	5 3/8	114
QD6C20.0	78346200	6	20.4	F	3 15/16	6 3/8	102
QD7C20.0	78347200	7	20.4	J	4 1/2	7 3/8	131
QD8C20.0	78348200	8	20.4	J	4 1/2	8 3/8	146
QD9C20.0	78349200	9	20.4	J	4 1/2	9 3/8	156
QD10C20.0	78350200	10	20.4	J	4 1/2	10 3/8	277
QD12C20.0	78352200	12	20.4	M	5 1/2	12 3/8	237
QD1C24.0	78341240	1	24.4	SF	2 15/16	1 3/8	31.8
QD2C24.0	78342240	2	24.4	SF	2 15/16	2 3/8	61
QD3C24.0	78343240	3	24.4	E	3 1/2	3 3/8	78
QD4C24.0	78344240	4	24.4	F	3 15/16	4 3/8	108
QD5C24.0	78345240	5	24.4	F	3 15/16	5 3/8	109
QD6C24.0	78346240	6	24.4	F	3 15/16	6 3/8	150
QD7C24.0	78347240	7	24.4	J	4 1/2	7 3/8	167
QD8C24.0	78348240	8	24.4	J	4 1/2	8 3/8	188
QD9C24.0	78349240	9	24.4	J	4 1/2	9 3/8	192
QD10C24.0	78350240	10	24.4	M	5 1/2	10 3/8	336
QD12C24.0	78352240	12	24.4	M	5 1/2	12 3/8	277
QD2C27.0	78342270	2	27.4	F	3 15/16	2 3/8	88
QD3C27.0	78343270	3	27.4	F	3 15/16	3 3/8	101
QD4C27.0	78344270	4	27.4	F	3 15/16	4 3/8	116
QD5C27.0	78345270	5	27.4	F	3 15/16	5 3/8	133
QD6C27.0	78346270	6	27.4	J	4 1/2	6 3/8	162
QD7C27.0	78347270	7	27.4	J	4 1/2	7 3/8	209

SECCIÓN C

DESCRIPCIÓN	CÓDIGO	NO. RANURAS	DIÁM. MÁX. (PULG.)	BUJE	DIÁM. MÁX. BARRENO (PULG.)	ANCHO (PULG.)	PESO (LBS.)
QD8C27.0	78348270	8	27.4	J	4 1/2	8 3/8	230
QD9C27.0	78349270	9	27.4	J	4 1/2	9 3/8	227
QD2C30.0	78342300	2	30.4	F	3 15/16	2 3/8	79
QD3C30.0	78343300	3	30.4	F	3 15/16	3 3/8	129
QD4C30.0	78344300	4	30.4	F	3 15/16	4 3/8	165
QD5C30.0	78345300	5	30.4	F	3 15/16	5 3/8	160
QD6C30.0	78346300	6	30.4	J	4 1/2	6 3/8	180
QD7C30.0	78347300	7	30.4	J	4 1/2	7 3/8	221
QD8C30.0	78348300	8	30.4	J	4 1/2	8 3/8	230
QD9C30.0	78349300	9	30.4	M	5 1/2	9 3/8	317
QD10C30.0	78350300	10	30.4	M	5 1/2	10 3/8	305
QD12C30.0	78352300	12	30.4	M	5 1/2	12 3/8	357
QD3C36.0	78343360	3	36.4	F	3 15/16	3 3/8	143
QD4C36.0	78344360	4	36.4	F	3 15/16	4 3/8	170
QD5C36.0	78345360	5	36.4	J	4 1/2	5 3/8	205
QD6C36.0	78346360	6	36.4	J	4 1/2	6 3/8	230
QD7C36.0	78347360	7	36.4	J	4 1/2	7 3/8	282
QD8C36.0	78348360	8	36.4	M	5 1/2	8 3/8	285
QD9C36.0	78349360	9	36.4	M	5 1/2	9 3/8	383
QD10C36.0	78350360	10	36.4	M	5 1/2	10 3/8	335
QD12C36.0	78352360	12	36.4	M	5 1/2	12 3/8	430
QD3C44.0	78343440	3	44.4	F	3 15/16	3 3/8	170
QD4C44.0	78344440	4	44.4	J	4 1/2	4 3/8	366
QD5C44.0	78345440	5	44.4	J	4 1/2	5 3/8	260
QD6C44.0	78346440	6	44.4	J	4 1/2	6 3/8	315
QD7C44.0	78347440	7	44.4	M	5 1/2	7 3/8	442
QD8C44.0	78348440	8	44.4	M	5 1/2	8 3/8	590
QD9C44.0	78349440	9	44.4	M	5 1/2	9 3/8	493
QD10C44.0	78350440	10	44.4	M	5 1/2	10 3/8	455
QD12C44.0	78352440	12	44.4	M	5 1/2	12 3/8	520
QD3C50.0	78343500	3	50.4	F	3 15/16	3 3/8	190
QD4C50.0	78344500	4	50.4	J	4 1/2	4 3/8	256
QD5C50.0	78345500	5	50.4	J	4 1/2	5 3/8	275
QD6C50.0	78346500	6	50.4	J	4 1/2	6 3/8	325
QD7C50.0	78347500	7	50.4	M	5 1/2	7 3/8	488
QD8C50.0	78348500	8	50.4	M	5 1/2	8 3/8	530
QD9C50.0	78349500	9	50.4	M	5 1/2	9 3/8	585
QD10C50.0	78350500	10	50.4	M	5 1/2	10 3/8	503
QD12C50.0	78352500	12	50.4	M	5 1/2	12 3/8	595

SECCIÓN D

DESCRIPCIÓN	CÓDIGO	NO. RANURAS	DIÁM. MÁX. (PULG.)	BUJE	DIÁM. MÁX. BARRENO (PULG.)	ANCHO (PULG.)	PESO (LBS.)
QD3D12.0	78363120	3	12.6	F	3 15/16	4 5/8	83
QD4D12.0	78364120	4	12.6	F	3 15/16	6 1/16	85
QD5D12.0	78365120	5	12.6	F	3 15/16	7 1/2	98
QD6D12.0	78366120	6	12.6	J	4 1/2	8 15/16	111
QD8D12.0	78368120	8	12.6	J	4 1/2	11 13/16	151
QD10D12.0	78370120	10	12.6	M	5 1/2	14 11/16	153
QD12D12.0	78372120	12	12.6	M	5 1/2	17 9/16	176
QD3D13.0	78363130	3	13.6	F	3 15/16	4 5/8	88
QD4D13.0	78364130	4	13.6	F	3 15/16	6 1/16	76
QD5D13.0	78365130	5	13.6	F	3 15/16	7 1/2	114
QD6D13.0	78366130	6	13.6	J	4 1/2	8 15/16	140
QD8D13.0	78368130	8	13.6	J	4 1/2	11 13/16	168
QD10D13.0	78370130	10	13.6	M	5 1/2	14 11/16	180
QD12D13.0	78372130	12	13.6	M	5 1/2	17 9/16	210
QD3D13.5	78363135	3	14.1	F	3 15/16	4 5/8	88
QD4D13.5	78364135	4	14.1	F	3 15/16	6 1/16	107
QD5D13.5	78365135	5	14.1	F	3 15/16	7 1/2	134
QD6D13.5	78366135	6	14.1	J	4 1/2	8 15/16	140
QD8D13.5	78368135	8	14.1	J	4 1/2	11 13/16	168
QD10D13.5	78370135	10	14.1	M	5 1/2	14 11/16	186
QD12D13.5	78372135	12	14.1	M	5 1/2	17 9/16	227
QD3D14.0	78363140	3	14.6	F	3 15/16	4 5/8	111
QD4D14.0	78364140	4	14.6	F	3 15/16	6 1/16	106
QD5D14.0	78365140	5	14.6	F	3 15/16	7 1/2	140
QD6D14.0	78366140	6	14.6	J	4 1/2	8 15/16	159
QD8D14.0	78368140	8	14.6	J	4 1/2	11 13/16	181
QD10D14.0	78370140	10	14.6	M	5 1/2	14 11/16	221
QD12D14.0	78372140	12	14.6	M	5 1/2	17 9/16	244
QD3D14.5	78363145	3	15.1	F	3 15/16	4 5/8	111
QD4D14.5	78364145	4	15.1	F	3 15/16	6 1/16	106
QD5D14.5	78365145	5	15.1	F	3 15/16	7 1/2	140
QD6D14.5	78366145	6	15.1	J	4 1/2	8 15/16	159
QD8D14.5	78368145	8	15.1	J	4 1/2	11 13/16	181
QD10D14.5	78370145	10	15.1	M	5 1/2	14 11/16	221
QD12D14.5	78372145	12	15.1	M	5 1/2	17 9/16	262
QD3D15.0	78363150	3	15.6	F	3 15/16	4 5/8	105
QD4D15.0	78364150	4	15.6	F	3 15/16	6 1/16	110
QD5D15.0	78365150	5	15.6	F	3 15/16	7 1/2	114
QD6D15.0	78366150	6	15.6	J	4 1/2	8 15/16	162
QD8D15.0	78368150	8	15.6	J	4 1/2	11 13/16	216
6 QD10D15.0	78370150	10	15.6	M	5 1/2	14 11/16	247
QD12D15.0	78372150	12	15.6	M	5 1/2	17 9/16	281
QD3D15.5	78363155	3	16.1	F	3 15/16	4 5/8	105
QD4D15.5	78364155	4	16.1	F	3 15/16	6 1/16	110

SECCIÓN D

DESCRIPCIÓN	CÓDIGO	NO. RANURAS	DIÁM. MÁX. (PULG.)	BUJE	DIÁM. MÁX. BARRENO (PULG.)	ANCHO (PULG.)	PESO (LBS.)
QD5D15.5	78365155	5	16.1	F	3 15/16	7 1/2	146
QD6D15.5	78366155	6	16.1	J	4 1/2	8 15/16	162
QD8D15.5	78368155	8	16.1	J	4 1/2	11 13/16	216
QD10D15.5	78370155	10	16.1	M	5 1/2	14 11/16	270
QD12D15.5	78372155	12	16.1	M	5 1/2	17 9/16	300
QD3D16.0	78363160	3	16.6	F	3 15/16	4 5/8	150
QD4D16.0	78364160	4	16.6	F	3 15/16	6 1/16	150
QD5D16.0	78365160	5	16.6	F	3 15/16	7 1/2	143
QD6D16.0	78366160	6	16.6	J	4 1/2	8 15/16	199
QD8D16.0	78368160	8	16.6	J	4 1/2	11 13/16	237
QD10D16.0	78370160	10	16.6	M	5 1/2	14 11/16	267
QD12D16.0	78372160	12	16.6	M	5 1/2	17 9/16	279
QD4D17.0	78364170	4	17.6	J	4 1/2	6/16	111
QD5D17.0	78365170	5	17.6	J	4 1/2	7 1/2	128
QD6D17.0	78366170	6	17.6	J	4 1/2	8 15/16	145
QD8D17.0	78368170	8	17.6	J	4 1/2	11 13/16	176
QD10D17.0	78370170	10	17.6	M	5 1/2	14 11/16	263
QD12D17.0	78372170	12	17.6	M	5 1/2	17 9/16	289
QD3D18.0	78363180	3	18.6	J	4 1/2	4 5/8	146
QD4D18.0	78364180	4	18.6	J	4 1/2	6 1/16	146
QD5D18.0	78365180	5	18.6	J	4 1/2	7 1/2	164
QD6D18.0	78366180	6	18.6	J	4 1/2	8 15/16	223
QD8D18.0	78368180	8	18.6	M	5 1/2	11 13/16	249
QD10D18.0	78370180	10	18.6	M	5 1/2	14 11/16	274
QD12D18.0	78372180	12	18.6	M	5 1/2	17 9/16	309
QD4D20.0	78364200	4	20.6	J	4 1/2	6 1/16	181
QD5D20.0	78365200	5	20.6	J	4 1/2	7 1/2	188
QD6D20.0	78366200	6	20.6	J	4 1/2	8 15/16	249
QD8D20.0	78368200	8	20.6	M	5 1/2	11 13/16	277
QD10D20.0	78370200	10	20.6	M	5 1/2	14 11/16	408
QD12D20.0	78372200	12	20.6	M	5 1/2	17 9/16	352
QD3D22.0	78363220	3	22.6	J	4 1/2	4 5/8	199
QD4D22.0	78364220	4	22.6	J	4 1/2	6 1/16	199
QD5D22.0	78365220	5	22.6	J	4 1/2	7 1/2	221
QD6D22.0	78366220	6	22.6	M	5 1/2	8 15/16	258
QD8D22.0	78368220	8	22.6	M	5 1/2	11 13/16	326
QD10D22.0	78370220	10	22.6	M	5 1/2	14 11/16	361
QD12D22.0	78372220	12	22.6	M	5 1/2	17 9/16	384
QD3D24.0	78363240	3	24.6	J	4 1/2	4 5/8	135
QD4D24.0	78364240	4	24.6	J	4 1/2	6/16	170
QD5D24.0	78365240	5	24.6	J	4 1/2	7 1/2	192
QD6D24.0	78366240	6	24.6	M	5 1/2	8 15/16	264
QD3D27.0	78363270	3	27.6	J	4 1/2	4 5/8	236
QD4D27.0	78364270	4	27.6	J	4 1/2	6 1/16	257

SECCIÓN D

DESCRIPCIÓN	CÓDIGO	NO. RANURAS	DIÁM. MÁX. (PULG.)	BUJE	DIÁM. MÁX. BARRENO (PULG.)	ANCHO (PULG.)	PESO (LBS.)
QD5D27.0	78365270	5	27.6	M	5 1/2	7 1/2	296
QD6D27.0	78366270	6	27.6	M	5 1/2	8 15/16	331
QD8D27.0	78368270	8	27.6	M	5 1/2	11 13/16	376
QD10D27.0	78370270	10	27.6	M	5 1/2	14 11/16	430
QD12D27.0	78372270	12	27.6	N	6	17 9/16	515
QD3D33.0	78363330	3	33.6	J	4 1/2	4 5/8	332
QD4D33.0	78364330	4	33.6	M	5 1/2	6 1/16	361
QD5D33.0	78365330	5	33.6	M	5 1/2	7 1/2	411
QD6D33.0	78366330	6	33.6	M	5 1/2	8 15/16	460
QD8D33.0	78368330	8	33.6	M	5 1/2	11 13/16	524
QD10D33.0	78370330	10	33.6	N	5 7/8	14 11/16	638
QD12D33.0	78372330	12	33.6	N	6	17 9/16	650
QD3D40.0	78363400	3	40.6	J	4 1/2	4 15/8	250
QD4D40.0	78364400	4	40.6	M	5 1/2	6 11/16	498
QD5D40.0	78365400	5	40.6	M	5 1/2	7 11/2	546
QD6D40.0	78366400	6	40.6	M	5 1/2	8 15/16	606
QD8D40.0	78368400	8	40.6	N	5 7/8	11 13/16	695
QD10D40.0	78370400	10	40.6	N	5 7/8	14 11/16	788
QD12D40.0	78372400	12	40.6	P	7	17 9/16	855
QD5D48.0	78365480	5	48.6	M	5 1/2	7 1/2	671
QD6D48.0	78366480		48.6	M	5 1/2	8 15/16	744
QD8D48.0	78368480		48.6	N	5 7/8	11 13/16	849
QD10D48.0	78370480		48.6	P	7	14 11/16	961
QD12D48.0	78372480		48.6	P	7	17 9/16	1085
QD5D58.0	78365580		58.6	M	5 1/2	7 1/2	750
QD6D58.0	78366580		58.6	N	5 7/8	8 15/16	800
QD8D58.0	78368580		58.6	N	5 7/8	11 13/16	975
QD10D58.0	78370580		58.6	P	7	14 11/16	1200
QD12D58.0	78372580		58.6	P	7	17 9/16	1395

BUJES QD®

TAMAÑOS INGLESES

MERCADOS / APLICACIONES

Use con todos los estilos de poleas QD y Sprockets.

CARACTERÍSTICAS/VENTAJAS

- Los bujes están fabricados con tolerancias precisas.
- Disponibles en tamaños de barrenos populares.

Notas:

ADVERTENCIA: El excesivo torque en tornillos con ranura puede causar que la polea y/o el buje se rompan. El uso de lubricantes puede resultar en fractura de la polea.

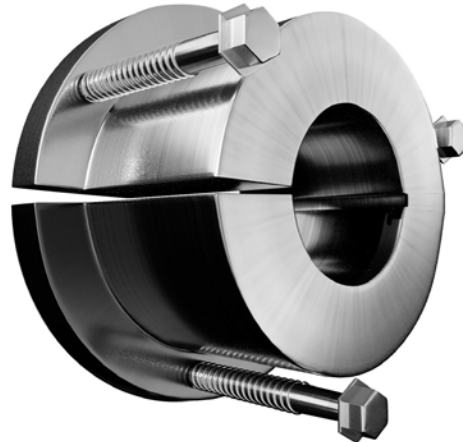

DESCRIPCIÓN	CÓDIGO	DIÁM. MÁX. BARRENO (PULG.)	PESO (LBS.)	DESCRIPCIÓN	CÓDIGO	DIÁM. MÁX. BARRENO (PULG.)	PESO (LBS.)	DESCRIPCIÓN	CÓDIGO	DIÁM. MÁX. BARRENO (PULG.)	PESO (LBS.)
E.7/8	78391014	7/8"	11.8	12 E 2.15/16	78391215	2 15/16	7.53	F 2.5/16	78392205	2	15.96
E 1.	78391100	1	11.65	12 E 3.	78391300	3	7.31	F 2.3/8	78392206	2 3/8	15.79
E 1.1/16	78391101	1 1/16	11.5	12 E 3.1/8	78391302	3 1/8	6.9	F 2.7/16	78392207	2	15.56
E 1.1/8	78391102	1 1/8	11.46	12 E 3.3/16	78391303	3 3/16	6.69	F 2.1/2	78392208	2 1/2	15.37
E 1.3/16	78391103	1 3/16	11.4	12 E 3.1/4	78391304	3 1/4	6.48	F 2.5/8	78392210	2 5/8	14.86
E 1.1/4	78391104	1 1/4	11.33	12 E 3.5/16	78391305	3 5/16	6.1	F 2.11/16	78392211	2 11/16	13.42
E 1.5/16	78391105	1 5/16	11.26	12 E 3.3/8	78391306	3 3/8	6.1	F 2.3/4	78392212	2 3/4	14.37
E 1.3/8	78391106	1 3/8	11.13	12 E 3.7/16	78391307	3 7/16	5.86	F 2.13/16	78392213	2 13/16	14
E 1.7/16	78391107	1 7/16	10.94	12 E 3.1/2	78391308	3 1/2	5.63	F 2.7/8	78392214	2 7/8	13.75
E 1.1/2	78391108	1 1/2	10.86	F 1.	78392100	1	19.41	F 2.15/16	78392215	2 15/16	13.47
E 1.5/8	78391110	1 5/8	10.69	F 1.1/8	78392102	1 1/8	19.15	F 3.	78392300	3	13.2
E 1.11/16	78391111	1 11/16	10.56	F 1.3/16	78392103	1 3/16	18	F 3.1/8	78392302	3 1/8	12.67
E 1.3/4	78391112	1 3/4	10.46	F 1.1/4	78392104	1 1/4	18.99	F 3.3/16	78392303	3	14
E 1.7/8	78391114	1 7/8	10.16	F 1.3/8	78392106	1 3/8	18.68	F 3.1/4	78392304	3 1/4	12
E 1.15/16	78391115	1 15/16	9.99	F 1.7/16	78392107	1 7/16	18.56	12 F 3.3/8	78392306	3 3/8	12.05
E 2.	78391200	2	9.94	F 1.1/2	78392108	1 1/2	18.48	12 F 3.7/16	78392307	3	11.73
E 2.1/8	78391202	2 1/8	9.62	NF 1.9/16	78392109	1 9/16	16.8	12 F 3.1/2	78392308	3 1/2	11.17
E 2.3/16	78391203	2 3/16	9.42	F 1.5/8	78392110	1 5/8	18.15	12 F 3.5/8	78392310	3 5/8	10.53
E 2.1/4	78391204	2 1/4	9.28	F	78392111	1	17.91	12 F 3.11/16	78392311	3 11/16	14
E 2.5/16	78391205	2 5/16	9.07	F 1.3/4	78392112	1 3/4	16.77	12 F 3.3/4	78392312	3 3/4	9.89
E 2.3/8	78391206	2 3/8	8.95	F 1.13/16	78392113	1 13/16	17.62	12 F 3.7/8	78392314	3 7/8	9.26
E 2.7/16	78391207	2 7/16	8.77	F 1.7/8	78392114	1 7/8	16.41	12 F 3.15/16	78392315	3 15/16	8.11
E 2.1/2	78391208	2 1/2	8.61	F 1.15/16	78392115	1 15/16	17.23	13 F 4.	78392400	4	7.96
E 2.5/8	78391210	2 5/8	8.23	F 2.	78392200	2	16.97	J 1.1/2	78393108	1 1/2	28.97
E 2.11/16	78391211	2 11/16	8.05	F 2.1/8	78392202	2 1/8	16.7	J 1.5/8	78393110	1 5/8	28.61
E 2.3/4	78391212	2 3/4	7.9	F 2.3/16	78392203	2	16.54	J 1.3/4	78393112	1 3/4	28.28
E 2.7/8	78391214	2 7/8	7.32	F 2.1/4	78392204	2 1/4	16.25	J 1.7/8	78393114	1 7/8	27.79

DESCRIPCIÓN	CÓDIGO	DIÁM. MÁX. BARRENO (PULG.)	PESO (LBS.)	DESCRIPCIÓN	CÓDIGO	DIÁM. MÁX. BARRENO (PULG.)	PESO (LBS.)	DESCRIPCIÓN	CÓDIGO	DIÁM. MÁX. BARRENO (PULG.)	PESO (LBS.)
J 1.15/16	78393115	1 15/16	27.53	J 3.1/2	78393308	3 1/2	19.25	JA.7/8	78380014	7/8	0.37
J 2.	78393200	2	27.33	J 3.5/8	78393310	3 5/8	18.44	JA.15/16	78380015	15/16	0.35
J 2.1/8	78393202	2 1/8	26.74	J 3.11/16	78393311	3 11/16	18.04	JA 1.	78380100	1	0.33
J 2.3/16	78393203	2	26.37	J 3.3/4	78393312	3 3/4	17.62	12 JA 1.1/16	78380101	1 1/16	0.34
J 2.1/4	78393204	2 1/4	26.32	12 J 3.7/8	78393314	3 7/8	17.8	12 JA 1.1/8	78380102	1 1/8	0.31
J 2.3/8	78393206	2 3/8	25.65	12 J 3.15/16	78393315	3 15/16	17.14	12 JA 1.3/16	78380103	1 3/16	0.29
J 2.7/16	78393207	2	25.38	12 J 4.	78393400	4	16.62	13 JA 1.1/4	78380104	1 1/4	0.25
J 2.1/2	78393208	2 1/2	25.05	12 J 4.1/8	78393402	4 1/8	15.69	M 2.	78394200	2	62.49
J 2.5/8	78393210	2 5/8	24.5	12 J 4.3/16	78393403	4 3/16	14.55	M 2.3/16	78394203	2 3/16	61.38
J 2.11/16	78393211	2 11/16	24.18	12 J 4.1/4	78393404	4 1/4	14.68	M 2.3/8	78394206	2 3/8	60.32
J 2.3/4	78393212	2 3/4	23.86	12 J 4.3/8	78393406	4 3/8	14	M 2.7/16	78394207	2 7/16	59.97
J 2.7/8	78393214	2 7/8	23.15	12 J 4.7/16	78393407	4 7/16	13.18	M 2.1/2	78394208	2 1/2	59.48
J 2.15/16	78393215	2 15/16	22.73	12 J 4.1/2	78393408	4 1/2	12.67	M 2.5/8	78394210	2 5/8	58.69
J 3.	78393300	3	22.43	JA.1/2	78380008	1/2	0.46	M 2.11/16	78394211	2 11/16	47.8
J 3.1/8	78393302	3 1/8	21.68	JA.9/16	78380009	9/16	0.46	M 2.3/4	78394212	2 3/4	57.86
J 3.3/16	78393303	3 3/16	21.35	JA.5/8	78380010	5/8	0.45	M 2.7/8	78394214	2 7/8	29.07
J 3.1/4	78393304	3 1/4	20.98	JA.11/16	78380011	11/16	0.43	M 2.15/16	78394215	2 15/16	56.17
J 3.3/8	78393306	3 3/8	20.1	JA.3/4	78380012	3/4	0.41	M 3.	78394300	3	55.55
J 3.7/16	78393307	3 7/16	19.71	JA.13/16	78380013	13/16	0.4	M 3.1/8	78394302	3 1/8	54

NO. PRODUCTO SERIES 7838 Y 7839

DESCRIPCIÓN	CÓDIGO	DIÁM. MÁX. BARRENO (PULG.)	PESO (LBS.)	DESCRIPCIÓN	CÓDIGO	DIÁM. MÁX. BARRENO (PULG.)	PESO (LBS.)	DESCRIPCIÓN	CÓDIGO	DIÁM. MÁX. BARRENO (PULG.)	PESO (LBS.)
M 3.3/16	78394303	3 3/16	53.84	12 M 5.	78394500	5	35.49	P 4.7/16	78396407	4 7/16	114
M 3.1/4	78394304	3 1/4	53.42	12 M 5.1/4	78394504	5 1/4	31.8	P 4.1/2	78396408	4 1/2	125
M 3.3/8	78394306	3 3/8	52.21	12 M 5.7/16	78394507	5 7/16	29.06	P 4.15/16	78396415	4 15/16	104
M 3.7/16	78394307	3 7/16	51.61	12 M 5.1/2	78394508	5 1/2	28.04	NP 5.	78396500	5	108.8
M 3.1/2	78394308	3 1/2	51.12	N 2.15/16	78395215	2 15/16	80	P 5.1/2	78396508	5 1/2	125
M 3.5/8	78394310	3 5/8	50.08	N 3.7/16	78395307	3 7/16	80	P 5.15/16	78396515	5 15/16	86.84
M 3.11/16	78394311	3 11/16	49	N 3.3/4	78395312	3 3/4	80	12 P 6.	78396600	6	70
M 3.3/4	78394312	3 3/4	48.47	N 3.7/8	78395314	3 7/8	80	12 P 7.	78396700	7	68
M 3.7/8	78394314	3 7/8	47.03	N 3.15/16	78395315	3 15/16	80	SD.1/2	78383008	1/2	2.07
M 3.15/16	78394315	3 15/16	46.26	N 4.	78395400	4	80	SD.9/16	78383009	9/16	2.05
M 4.	78394400	4	47.8	N 4.3/16	78395403	4 3/16	80	SD.5/8	78383010	5/8	2.03
M 4.1/8	78394402	4 1/8	44.24	N 4.1/4	78395404	4 1/4	80	SD.11/16	78383011	11/16	2
M 4.3/16	78394403	4 3/16	43.64	N 4.7/16	78395407	4 7/16	64.23	SD.3/4	78383012	3/4	1.96
M 4.1/4	78394404	4 1/4	42.81	N 4.1/2	78395408	4 1/2	60	SD.13/16	78383013	13/16	2.01
M 4.3/8	78394406	4 3/8	41.46	N 4.3/4	78395412	4 3/4	80	SD.7/8	78383014	7/8	1.88
M 4.7/16	78394407	4 7/16	40.6	N 4.7/8	78395414	4 7/8	80	SD.15/16	78383015	15/16	1.85
M 4.1/2	78394408	4 1/2	39.89	N 4.15/16	78395415	4 15/16	56.06	SD 1.	78383100	1	1.8
M 4.11/16	78394411	4 11/16	36.98	N 5.	78395500	5	54.89	SD 1.1/16	78383101	1 1/16	1.79
M 4.3/4	78394412	4 3/4	36.25	12 N 5.1/2	78395508	5 1/2	49.02	SD 1.1/8	78383102	1 1/8	1.72
12 M 4.7/8	78394414	4 7/8	36.89	12 N 5.7/8	78395514	5 7/8	44	SD 1.3/16	78383103	1 3/16	1.67
12 M 4.15/16	78394415	4 15/16	36.78	P 3.7/16	78396307	3 7/16	134	SD 1.1/4	78383104	1 1/4	1.62

DESCRIPCIÓN	CÓDIGO	DIÁM. MÁX. BARRENO (PULG.)	PESO (LBS.)	DESCRIPCIÓN	CÓDIGO	DIÁM. MÁX. BARRENO (PULG.)	PESO (LBS.)	DESCRIPCIÓN	CÓDIGO	DIÁM. MÁX. BARRENO (PULG.)	PESO (LBS.)
SD 1.5/16	78383105	1 5/16	1.55	SF.15/16	78385015	15/16	5.05	SH 1.5/16	78381105	1 5/16	0.82
SD 1.3/8	78383106	1 3/8	1.5	SF 1.	78385100	1	5	SH 1.3/8	78381106	1 3/8	0.8
SD 1.7/16	78383107	1 7/16	1.44	SF 1.1/8	78385102	1 1/8	4.9	12 SH 1.7/16	78381107	1 7/16	0.79
SD 1.1/2	78383108	1 1/2	1.36	SF 1.3/16	78385103	1 3/16	4.83	12 SH 1.1/2	78381108	1 1/2	0.75
SD 1.9/16	78383109	1 9/16	1.29	SF 1.1/4	78385104	1 1/4	4.77	12 SH 1.9/16	78381109	1 9/16	0.9
SD 1.5/8	78383110	1 5/8	1.29	SF 1.5/16	78385105	1 5/16	4.71	12 SH 1.5/8	78381110	1 5/8	0.64
12 SD 1.11/16	78383111	1 11/16	1.27	SF 1.3/8	78385106	1 3/8	4.61	13 SH 1.11/16	78381111	1 11/16	0.55
12 SD 1.3/4	78383112	1 3/4	1.28	SF 1.7/16	78385107	1 7/16	4.57	SK.1/2	78384008	1/2	3.77
12 SD 1.13/16	78383113	1 13/16	1.15	SF 1.1/2	78385108	1 1/2	4.48	SK.5/8	78384010	5/8	3.72
12 SD 1.7/8	78383114	1 7/8	1.07	SF 1.9/16	78385109	1 9/16	4.42	SK.11/16	78384011	11/16	3.7
12 SD 1.15/16	78383115	1 15/16	1	SF 1.5/8	78385110	1 5/8	4.32	SK.3/4	78384012	3/4	3.61
13 SD 2.	78383200	2	1.3	SF 1.11/16	78385111	1 11/16	4.31	SK.13/16	78384013	13/16	3.53
SDS.1/2	78382008	1/2	1.65	SF 1.3/4	78385112	1 3/4	4.16	SK.7/8	78384014	7/8	3.58
SDS.9/16	78382009	9/16	1.65	SF 1.13/16	78385113	1 13/16	4.06	SK.15/16	78384015	15/16	3.52
SDS.5/8	78382010	5/8	1.61	SF 1.7/8	78385114	1 7/8	4	SK 1.	78384100	1	3.45
SDS.11/16	78382011	11/16	1.6	SF 1.15/16	78385115	1 15/16	3.87	SK 1.1/16	78384101	1 1/16	3.41
SDS.3/4	78382012	3/4	1.58	SF 2.	78385200	2	3.78	SK 1.1/8	78384102	1 1/8	3.37
SDS.13/16	78382013	13/16	1.54	SF 2.1/16	78385201	2 1/16	3.7	SK 1.3/16	78384103	1 3/16	3.31
SDS.7/8	78382014	7/8	1.54	SF 2.1/8	78385202	2 1/8	3.57	SK 1.1/4	78384104	1 1/4	3.31
SDS.15/16	78382015	15/16	1.5	SF 2.3/16	78385203	2 3/16	3.45	SK 1.5/16	78384105	1 5/16	3.18
SDS 1.	78382100	1	1.46	SF 2.1/4	78385204	2 1/4	3.38	SK 1.3/8	78384106	1 3/8	3.12
SDS 1.1/16	78382101	1 1/16	1.43	SF 2.5/16	78385205	2 5/16	3.32	SK 1.7/16	78384107	1 7/16	3.08
SDS 1.1/8	78382102	1 1/8	1.38	12 SF 2.3/8	78385206	2 3/8	3.39	SK 1.1/2	78384108	1 1/2	3
SDS 1.3/16	78382103	1 3/16	1.36	12 SF 2.7/16	78385207	2 7/16	3.26	SK 1.9/16	78384109	1 9/16	2.95
SDS 1.1/4	78382104	1 1/4	1.32	12 SF 2.1/2	78385208	2 1/2	3.16	SK 1.5/8	78384110	1 5/8	2.86
SDS 1.5/16	78382105	1 5/16	1.26	12 SF 2.5/8	78385210	2 5/8	2.91	SK 1.11/16	78384111	1 11/16	2.79
SDS 1.3/8	78382106	1 3/8	1.24	12 SF 2.11/16	78385211	2 11/16	2.72	SK 1.3/4	78384112	1 3/4	2.88
SDS 1.7/16	78382107	1 7/16	1.19	12 SF 2.3/4	78385212	2 3/4	2.59	SK 1.13/16	78384113	1 13/16	2.62
SDS 1.1/2	78382108	1 1/2	1.15	12 SF 2.13/16	78385213	2 13/16	3.5	SK 1.7/8	78384114	1 7/8	2.5
SDS 1.9/16	78382109	1 9/16	1.11	13 SF 2.7/8	78385214	2 7/8	2.35	SK 1.15/16	78384115	1 15/16	2.42
SDS 1.5/8	78382110	1 5/8	1.08	13 SF 2.15/16	78385215	2 15/16	2.22	SK 2.	78384200	2	2.32
12 SDS 1.11/16	78382111	1 11/16	1.08	SH.1/2	78381008	1/2	1.16	SK 2.1/16	78384201	2 1/16	2.26
12 SDS 1.3/4	78382112	1 3/4	1.02	SH.9/16	78381009	9/16	1.14	SK 2.1/8	78384202	2 1/8	2.17
12 SDS 1.13/16	78382113	1 13/16	0.98	SH.5/8	78381010	5/8	1.14	12 SK 2.3/16	78384203	2 3/16	2.21
12 SDS 1.7/8	78382114	1 7/8	0.92	SH.11/16	78381011	11/16	1.14	12 SK 2.1/4	78384204	2 1/4	2.09
12 SDS 1.15/16	78382115	1 15/16	0.87	SH.3/4	78381012	3/4	1.1	12 SK 2.5/16	78384205	2 5/16	1.5
13 SDS 2.	78382200	2	0.77	SH.13/16	78381013	13/16	1.07	12 SK 2.3/8	78384206	2 3/8	1.91
SF.1/2	78385008	1/2	5.27	SH.7/8	78381014	7/8	1.04	12 SK 2.7/16	78384207	2 7/16	1.81
SF.5/8	78385010	5/8	5.22	SH.15/16	78381015	15/16	1	12 SK 2.1/2	78384208	2 1/2	2
0 SF.11/16	78385011	11/16	5.2	SH 1.	78381100	1	0.98	N SK 2.9/16	78384209	2 9/16	1.3
SF.3/4	78385012	3/4	5.17	SH 1.1/16	78381101	1 1/16	0.94	13 SK 2.5/8	78384210	2 5/8	1.32
SF.7/8	78385014	7/8	5.08	SH 1.1/8	78381102	1 1/8	0.91				
				SH 1.3/16	78381103	1 3/16	0.88				
				SH 1.1/4	78381104	1 1/4	0.84				

BUJES QD®

TAMAÑOS MILIMÉTRICOS

MERCADOS / APLICACIONES

Úsese con todos los tipos de poleas QD y sprockets con buje QD

CARACTERÍSTICAS / VENTAJAS

- Los bujes están fabricados con tolerancias precisas.
- Disponibles en tamaños de barrenos populares.

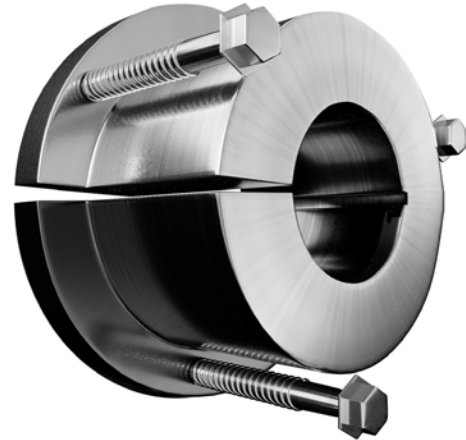

ADVERTENCIA: El excesivo torque en tornillos con ranura puede causar que la polea y/o el buje se rompan. El uso de lubricantes puede resultar en fractura de la polea.

5VS

DESCRIPCIÓN	CÓDIGO	DIÁM. MÁX. BARRENO (PULG.)	PESO (LBS.)
N 5VSLB 2.3/8	79640001	2 3/8	13
N 5VSLB 2.7/8	79640002	2 7/8	12
N 5VSLB 3.3/8	79640003	3 3/8	6
N 5VSSB 1.7/8	79640004	1 7/8	15
N 5VSSB 2.1/8	79640005	2 1/8	13
N 5VSSB 2.3/8	79640006	2 3/8	11.5
N 5VSSB 2.7/8	79640007	2 7/8	9
N 5VSSB 3.3/8	79640008	3 3/8	5.6

8VS

DESCRIPCIÓN	CÓDIGO	DIÁM. MÁX. BARRENO (PULG.)	PESO (LBS.)
N 8VSLB 3.3/8	79640009	3 3/8	53
N 8VSLB 3.7/8	79640010	3 7/8	46
N 8VSLB 4.3/8	79640011	4 3/8	35
N 8VSSB 3.3/8	79640012	3 3/8	45
N 8VSSB 3.7/8	79640013	3 7/8	38

BUJES QD®

RETRABAJABLES

MERCADOS / APLICACIONES

Use con todos los estilos de poleas QD y sprockets

CARACTERÍSTICAS / VENTAJAS

- Los soportes están fabricados con tolerancias muy precisas.

Notas: Disponible en mínimo barreno piloto. NKS significa No Keyseats (no asientos de llave). Los bujes re-trabajables son almacenados sin la hendidura para facilitar el remaquinado. La hendidura debe ser hecha en el buje para permitirle la compresión para propia acción de agarre de la flecha.



NO. PRODUCTO SERIES 7830

BUJE RETRABAJABLE CON ACERO INCRUSTADO

DESCRIPCIÓN	CÓDIGO	DIÁM. MÁX. BARRENO (PULG.)	PESO (LBS.)
E 50MM	78411200	50	10.15
E 60MM	78411206	60	9.03
J 55MM	78413203	55	26.4
J 70MM	78413212	70	21
SD 35MM	78403106	35	1.49
SD 42MM	78403111	42	1.18
SDS 24MM	78402015	24	1.5
SDS 25MM	78402100	25	1.47
SDS 28MM	78402101	28	1.4
SDS 30MM	78402103	30	1.35
SDS 35MM	78402106	35	1.22
SDS 38MM	78402108	38	1
SDS 42MM	78402111	42	1.02
SF 50MM	78405200	50	3.8
SF 60MM	78405206	60	3.14

BUJE RETRABAJABLE CON ACERO INCRUSTADO

DESCRIPCIÓN	CÓDIGO	DIÁM. MÁX. BARRENO (PULG.)	PESO (LBS.)
SH 24MM	78401015	24	1
SH 28MM	78401101	28	0.65
SH 30MM	78401103	30	0.85
SH 35MM	78401106	35	1
SK 24MM	78404015	24	3.5
SK 25MM	78404100	25	3.48
SK 30MM	78404103	30	3.33
SK 32MM	78404104	32	3.22
SK 35MM	78404106	35	3.13
SK 38MM	78404108	38	3
SK 40MM	78404109	40	2.91
SK 42MM	78404111	42	2.8
SK 48MM	78404114	48	2.35
SK 50MM	78404200	50	2.39

BUJES TL®

TAMAÑOS INGLESES

MERCADOS/APLICACIONES

Use con todos los estilos de poleas TaperLock y sprockets.

CARACTERÍSTICAS/VENTAJAS

- Los bujes son hechos para tolerancias precisas
- Disponible en tamaños de barrenos populares

Nota: La nomenclatura se entiende como sigue: p.e. 1008.9/16, 1008= número del buje, 9/16=con diámetro de barreno de 9/16.



NO. PRODUCTO SERIES 7848 Y 7858

DESCRIPCIÓN	CÓDIGO	DIÁM. MÁX. BARRENO (PULG.)	PESO (LBS.)	DESCRIPCIÓN	CÓDIGO	DIÁM. MÁX. BARRENO (PULG.)	PESO (LBS.)	DESCRIPCIÓN	CÓDIGO	DIÁM. MÁX. BARRENO (PULG.)	PESO (LBS.)
1008.1/2	78580008	1/2	0.27	1310.7/8	78484014	7/8	0.56	2012.11/16	78582511	11/16	1.57
1008.9/16	78580009	9/16	0.25	13.101	78484100	1	0.52	2012.3/4	78582512	3/4	1.15
1008.5/8	78580010	5/8	0.24	1310 1.1/16	78484101	1 1/16	0.49	2012.13/16	78582513	13/16	1.53
1008.11/16	78580011	11/16	0.23	1310 1.1/8	78484102	1 1/8	0.47	2012.7/8	78582514	7/8	1.51
1008.3/4	78580012	3/4	0.21	1310 1.3/16	78484103	1 3/16	0.44	2012.15/16	78582515	15/16	1.47
1008.13/16	78580013	13/16	0.2	1310 1.1/4	78484104	1 1/4	0.41	20.121	78582600	1	1.46
1008.7/8	78580014	7/8	0.18	1310 1.3/8	78484106	1 3/8	0.35	2012 1.1/16	78582601	1 1/16	1.43
12 1008.15/16	78580015	15/16	0.17	1310 1.7/16	78484107	1 7/16	0.4	2012 1.1/8	78582602	1 1/8	1.39
12 1008 1.	78580100	1	0.15	1610.1/2	78581608	1/2	0.85	2012 1.3/16	78582603	1 3/16	1.36
1108.1/2	78580108	1/2	0.31	1610.9/16	78581609	9/16	0.85	2012 1.1/4	78582604	1 1/4	1.33
1108.9/16	78580109	9/16	0.31	1610.5/8	78581610	5/8	0.83	2012 1.5/16	78582605	1 5/16	1.27
1108.5/8	78580110	5/8	0.29	1610.11/16	78581611	11/16	0.83	2012 1.3/8	78582606	1 3/8	1.25
1108.11/16	78580111	11/16	0.28	1610.3/4	78581612	3/4	0.79	2012 1.7/16	78582607	1 7/16	1.2
1108.3/4	78580112	3/4	0.27	1610.13/16	78581613	13/16	0.84	2012 1.1/2	78582608	1 1/2	1.15
1108.13/16	78580113	13/16	0.25	1610.7/8	78581614	7/8	0.76	2012 1.9/16	78582609	1 9/16	1.1
1108.7/8	78580114	7/8	0.24	1610.15/16	78581615	15/16	0.72	2012 1.5/8	78582610	1 5/8	1.05
1108.15/16	78580115	15/16	0.21	16.101	78581700	1	0.71	2012 1.11/16	78582611	1 11/16	1.02
11,081	78580200	1	0.19	1610 1.1/16	78581701	1 1/16	0.69	2012 1.3/4	78582612	1 3/4	0.95
12 1108 1.1/16	78580201	1 1/16	0.19	1610 1.1/8	78581702	1 1/8	0.66	2012 1.13/16	78582613	1 13/16	0.88
12 1108 1.1/8	78580202	1 1/8	0.16	1610 1.3/16	78581703	1 3/16	0.63	2012 1.7/8	78582614	1 7/8	0.83
1210.1/2	78580508	1/2	0.58	1610 1.1/4	78581704	1 1/4	0.61	2012 1.15/16	78582615	1 15/16	0.86
1210.9/16	78580509	9/16	0.56	1610 1.5/16	78581705	1 5/16	0.57	12 2012 2.	78582700	2	0.8
1210.5/8	78580510	5/8	0.54	1610 1.3/8	78581706	1 3/8	0.54	2012 2.1/8	78582702	2 1/8	0.77
1210.11/16	78580511	11/16	0.53	1610 1.7/16	78581707	1 7/16	0.5	2517.1/2	78583008	1/2	3.44
1210.3/4	78580512	3/4	0.52	1610 1.1/2	78581708	1 1/2	0.47	2517.5/8	78583010	5/8	3.37
1210.13/16	78580513	13/16	0.49	1610 1.9/16	78581709	1 9/16	0.47	2517.11/16	78583011	11/16	3.35
1210.7/8	78580514	7/8	0.48	1610 1.5/8	78581710	1 5/8	0.43	2517.3/4	78583012	3/4	3.33
1210.15/16	78580515	15/16	0.47	1610 1.11/16	78581711	1 11/16	0.45	2517.13/16	78583013	13/16	3.34
12,101	78580600	1	0.43	1615.1/2	78582008	1/2	1.24	2517.7/8	78583014	7/8	3.52

NO. PRODUCTO SERIES 7848 Y 7858

DESCRIPCIÓN	CÓDIGO	DIÁM. MÁX. BARRENO (PULG.)	PESO (LBS.)	DESCRIPCIÓN	CÓDIGO	DIÁM. MÁX. BARRENO (PULG.)	PESO (LBS.)	DESCRIPCIÓN	CÓDIGO	DIÁM. MÁX. BARRENO (PULG.)	PESO (LBS.)
1210 1.1/16	78580601	1 1/16	0.41	1615.9/16	78582009	9/16	1.3	2517.15/16	78583015	15/16	3.26
1210 1.1/8	78580602	1 1/8	0.38	1615.5/8	78582010	5/8	1.2	25,171	78583100	1	3.18
1210 1.3/16	78580603	1 3/16	0.36	1615.11/16	78582011	11/16	1.24	2517 1.1/16	78583101	1 1/16	3.18
1210 1.1/4	78580604	1 1/4	0.32	1615.3/4	78582012	3/4	1.16	2517 1.1/8	78583102	1 1/8	3.09
1215.1/2	78581008	1/2	0.82	1615.13/16	78582013	13/16	1.2	2517 1.3/16	78583103	1 3/16	3.06
1215.9/16	78581009	9/16	0.85	1615.7/8	78582014	7/8	1.11	2517 1.1/4	78583104	1 1/4	3
1215.5/8	78581010	5/8	0.78	1615.15/16	78582015	15/16	1.06	2517 1.5/16	78583105	1 5/16	2.93
1215.11/16	78581011	11/16	0.81	16,151	78582100	1	1.02	2517 1.3/8	78583106	1 3/8	2.89
1215.3/4	78581012	3/4	0.75	1615 1.1/16	78582101	1 1/16	0.99	2517 1.7/16	78583107	1 7/16	2.83
1215.13/16	78581013	13/16	0.75	1615 1.1/8	78582102	1 1/8	0.95	2517 1.1/2	78583108	1 1/2	2.78
1215.7/8	78581014	7/8	0.68	1615 1.3/16	78582103	1 3/16	0.91	2517 1.9/16	78583109	1 9/16	2.7
1215.15/16	78581015	15/16	0.64	1615 1.1/4	78582104	1 1/4	0.87	2517 1.5/8	78583110	1 5/8	2.65
12,151	78581100	1	0.61	1615 1.5/16	78582105	1 5/16	0.82	2517 1.11/16	78583111	1 11/16	2.57
1215 1.1/16	78581101	1 1/16	0.57	1615 1.3/8	78582106	1 3/8	0.77	2517 1.3/4	78583112	1 3/4	2.52
1215 1.1/8	78581102	1 1/8	0.54	1615 1.7/16	78582107	1 7/16	0.72	2517 1.13/16	78583113	1 13/16	2.41
1215 1.3/16	78581103	1 3/16	0.49	1615 1.1/2	78582108	1 1/2	0.66	2517 1.7/8	78583114	1 7/8	2.34
1215 1.1/4	78581104	1 1/4	0.45	12 1615 1.9/16	78582109	1 9/16	0.67	2517 1.15/16	78583115	1 15/16	2.27
1310.1/2	78484008	1/2	0.66	12 1615 1.5/8	78582110	1 5/8	0.6	25,172	78583200	2	2.16
1310.9/16	78484009	9/16	0.64	12 1615 1.11/16	78582111	1 11/16	0.62	2517 2.1/16	78583201	2 1/16	2.1
1310.5/8	78484010	5/8	0.63	2012.1/2	78582508	1/2	1.63	2517 2.1/8	78583202	2 1/8	2.02
1310.11/16	78484011	11/16	0.62	2012.9/16	78582509	9/16	1.61	2517 2.3/16	78583203	2 3/16	1.94
1310.3/4	78484012	3/4	0.61	2012.5/8	78582510	5/8	1.59	2517 2.1/4	78583204	2 1/4	1.82

NO. PRODUCTO SERIES 7848 Y 7858

DESCRIPCIÓN	CÓDIGO	DIÁM. MÁX. BARRENO (PULG.)	PESO (LBS.)	DESCRIPCIÓN	CÓDIGO	DIÁM. MÁX. BARRENO (PULG.)	PESO (LBS.)	DESCRIPCIÓN	CÓDIGO	DIÁM. MÁX. BARRENO (PULG.)	PESO (LBS.)
2517 2.5/16	78583205	2 5/16	1.89	3030 2.3/16	78592203	2 3/16	6.97	3535 1.7/8	78593114	1 7/8	13.2
2517 2.3/8	78583206	2 3/8	1.78	3030 2.1/4	78592204	2 1/4	6.77	3535 1.15/16	78593115	1 15/16	13.16
2517 2.7/16	78583207	2 7/16	1.69	3030 2.5/16	78592205	2 5/16	6.57	35,352	78593200	2	13.11
2517 2.1/2	78583208	2 1/2	1.59	3030 2.3/8	78592206	2 3/8	6.39	3535 2.1/8	78593202	2 1/8	12.75
12517 2.5/8	78583210	2 5/8	1.8	3030 2.7/16	78592207	2 7/16	6.26	3535 2.3/16	78593203	2 3/16	12.59
2517 2.11/16	78583211	2 11/16	1.43	3030 2.1/2	78592208	2 1/2	6.08	3535 2.1/4	78593204	2 1/4	12.4
2525 1.5/8	78591110	1 5/8	3.85	3030 2.5/8	78592210	2 5/8	5.66	3535 2.3/8	78593206	2 3/8	12
2525 1.15/16	78591115	1 15/16	3.28	3030 2.11/16	78592211	2 11/16	5.5	3535 2.7/16	78593207	2 7/16	11.69
25,252	78591200	2	3.17	3030 2.3/4	78592212	2 3/4	5.28	3535 2.1/2	78593208	2 1/2	11.51
2525 2.1/8	78591202	2 1/8	2.89	3030 2.7/8	78592214	2 7/8	5.26	3535 2.5/8	78593210	2 5/8	11.02
2525 2.3/16	78591203	2 3/16	2.5	3030 2.15/16	78592215	2 15/16	4.99	3535 2.11/16	78593211	2 11/16	10.79
2525 2.5/16	78591205	2 5/16	2.73	30,303	78592300	3	4.78	3535 2.3/4	78593212	2 3/4	10.58
2525 2.1/2	78591208	2 1/2	2.19	3030 3.1/8	78592302	3 1/8	4.69	3535 2.7/8	78593214	2 7/8	10.02
3020.7/8	78596014	7/8	6.21	3030 3.3/16	78592303	3 3/16	4.8	3535 2.15/16	78593215	2 15/16	9.75
3020.15/16	78596015	15/16	6.1	3030 3.1/4	78592304	3 1/4	4.8	35,353	78593300	3	9.5
30,201	78596100	1	6.08	3525 1.3/16	78585103	1 3/16	16	3535 3.1/8	78593302	3 1/8	8.94
3020 1.1/8	78596102	1 1/8	5.93	3525 1.1/4	78585104	1 1/4	14.6	3535 3.3/16	78593303	3 3/16	8.66

NO. PRODUCTO SERIES 7848 Y 7858

DESCRIPCIÓN	CÓDIGO	DIÁM. MÁX. BARRENO (PULG.)	PESO (LBS.)	DESCRIPCIÓN	CÓDIGO	DIÁM. MÁX. BARRENO (PULG.)	PESO (LBS.)	DESCRIPCIÓN	CÓDIGO	DIÁM. MÁX. BARRENO (PULG.)	PESO (LBS.)
3020 1.3/16	78596103	1 3/16	5.95	3525 1.5/16	78585105	1 5/16	14.6	3535 3.1/4	78593304	3 1/4	8.3
3020 1.1/4	78596104	1 1/4	5.86	3525 1.3/8	78585106	1 3/8	14.3	3535 3.5/16	78593305	3 5/16	8.7
3020 1.5/16	78596105	1 5/16	5.81	3525 1.7/16	78585107	1 7/16	14.1	3535 3.3/8	78593306	3 3/8	8.44
3020 1.3/8	78596106	1 3/8	5.72	3525 1.1/2	78585108	1 1/2	14	3535 3.7/16	78593307	3 7/16	8.13
3020 1.7/16	78596107	1 7/16	5.65	3525 1.9/16	78585109	1 9/16	14	3535 3.1/2	78593308	3 1/2	7.9
3020 1.1/2	78596108	1 1/2	5.6	3525 1.5/8	78585110	1 5/8	13.9	3535 3.5/8	78593310	3 5/8	7.09
3020 1.9/16	78596109	1 9/16	5.9	3525 1.11/16	78585111	1 11/16	13.9	3535 3.11/16	78593311	3 11/16	6.79
3020 1.5/8	78596110	1 5/8	5.47	3525 1.3/4	78585112	1 3/4	13.4	3535 3.3/4	78593312	3 3/4	6.41
3020 1.11/16	78596111	1 11/16	5.36	3525 1.13/16	78585113	1 13/16	13.3	3535 3.7/8	78593314	3 7/8	5.94
3020 1.3/4	78596112	1 3/4	5.28	3525 1.7/8	78585114	1 7/8	13.2	3535 3.15/16	78593315	3 15/16	5.58
3020 1.13/16	78596113	1 13/16	5.53	3525 1.15/16	78585115	1 15/16	13	4030 1.7/16	78586107	1 7/16	24
3020 1.7/8	78596114	1 7/8	5.11	35,252	78585200	2	13	4030 1.1/2	78586108	1 1/2	22
3020 1.15/16	78596115	1 15/16	5.01	3525 2.1/16	78585201	2 1/16	12.9	4030 1.9/16	78586109	1 9/16	21.9
30,202	78596200	2	4.92	3525 2.1/8	78585202	2 1/8	12.6	4030 1.5/8	78586110	1 5/8	21.8
3020 2.1/16	78596201	2 1/16	4.81	3525 2.3/16	78585203	2 3/16	12.4	4030 1.11/16	78586111	1 11/16	21.5
3020 2.1/8	78596202	2 1/8	4.72	3525 2.1/4	78585204	2 1/4	12.3	4030 1.3/4	78586112	1 3/4	21.2
3020 2.3/16	78596203	2 3/16	4.63	3525 2.5/16	78585205	2 5/16	11.8	4030 1.13/16	78586113	1 13/16	21
3020 2.1/4	78596204	2 1/4	4.5	3525 2.3/8	78585206	2 3/8	12	4030 1.7/8	78586114	1 7/8	20.9
3020 2.5/16	78596205	2 5/16	4.37	3525 2.7/16	78585207	2 7/16	11.7	4030 1.15/16	78586115	1 15/16	20.7
3020 2.3/8	78596206	2 3/8	4.28	3525 2.1/2	78585208	2 1/2	11.5	40,302	78586200	2	20.6
3020 2.7/16	78596207	2 7/16	4.16	3525 2.9/16	78585209	2 9/16	11.4	4030 2.1/16	78586201	2 1/16	20.6
3020 2.1/2	78596208	2 1/2	4.05	3525 2.5/8	78585210	2 5/8	11.1	4030 2.1/8	78586202	2 1/8	20.7
3020 2.5/8	78596210	2 5/8	3.78	3525 2.11/16	78585211	2 11/16	10.7	4030 2.3/16	78586203	2 3/16	20.4
3020 2.11/16	78596211	2 11/16	3.67	3525 2.3/4	78585212	2 3/4	10.4	4030 2.1/4	78586204	2 1/4	20.1
3020 2.3/4	78596212	2 3/4	3.62	3525 2.13/16	78585213	2 13/16	10.3	4030 2.5/16	78586205	2 5/16	20
3020 2.13/16	78596213	2 13/16	3.66	3525 2.7/8	78585214	2 7/8	10.1	4030 2.3/8	78586206	2 3/8	19.5
3020 2.7/8	78596214	2 7/8	3.54	3525 2.15/16	78585215	2 15/16	10.5	4030 2.7/16	78586207	2 7/16	19.3
3020 2.15/16	78596215	2 15/16	3.43	35,253	78585300	3	9.5	4030 2.1/2	78586208	2 1/2	19.2
30,203	78596300	3	3.27	3525 3.1/16	78585301	3 1/16	9.4	4030 2.9/16	78586209	2 9/16	19.1
3020 3.1/8	78596302	3 1/8	3.35	3525 3.1/8	78585302	3 1/8	9.3	4030 2.5/8	78586210	2 5/8	19
3020 3.3/16	78596303	3 3/16	3.13	3525 3.3/16	78585303	3 3/16	8.6	4030 2.11/16	78586211	2 11/16	18.4
3020 3.1/4	78596304	3 1/4	2.96	3525 3.1/4	78585304	3 1/4	8.8	4030 2.3/4	78586212	2 3/4	17.7
30,301	78592100	1	9.36	3525 3.5/16	78585305	3 5/16	8.7	4030 2.13/16	78586213	2 13/16	17.5
3030 1.1/8	78592102	1 1/8	9.2	3525 3.3/8	78585306	3 3/8	8.5	4030 2.7/8	78586214	2 7/8	17.2
3030 1.3/16	78592103	1 3/16	9.14	3525 3.7/16	78585307	3 7/16	8.2	4030 2.15/16	78586215	2 15/16	17.2
3030 1.1/4	78592104	1 1/4	9.08	3525 3.1/2	78585308	3 1/2	8	40,303	78586300	3	17
3030 1.5/16	78592105	1 5/16	8.98	3525 3.9/16	78585309	3 9/16	8	4030 3.1/16	78586301	3 1/16	16.8
3030 1.3/8	78592106	1 3/8	8.75	3525 3.5/8	78585310	3 5/8	7.9	4030 3.1/8	78586302	3 1/8	16.5
3030 1.7/16	78592107	1 7/16	8.75	3525 3.11/16	78585311	3 11/16	7.9	4030 3.3/16	78586303	3 3/16	15.9
3030 1.1/2	78592108	1 1/2	8.59	3525 3.3/4	78585312	3 3/4	7.9	4030 3.1/4	78586304	3 1/4	15.4
3030 1.9/16	78592109	1 9/16	8.47	3525 3.13/16	78585313	3 13/16	7.9	4030 3.5/16	78586305	3 5/16	14.9
3030 1.5/8	78592110	1 5/8	8.28	3525 3.7/8	78585314	3 7/8	7.9	4030 3.3/8	78586306	3 3/8	14.6
3030 1.3/4	78592112	1 3/4	8.03	3525 3.15/16	78585315	3 15/16	7.9	4030 3.7/16	78586307	3 7/16	14.1
3030 1.13/16	78592113	1 13/16	8	3535 1.3/16	78593103	1 3/16	15.08	4030 3.1/2	78586308	3 1/2	13.4

NO. PRODUCTO SERIES 7848 Y 7858

DESCRIPCIÓN	CÓDIGO	DIÁM. MÁX. BARRENO (PULG.)	PESO (LBS.)	DESCRIPCIÓN	CÓDIGO	DIÁM. MÁX. BARRENO (PULG.)	PESO (LBS.)	DESCRIPCIÓN	CÓDIGO	DIÁM. MÁX. BARRENO (PULG.)	PESO (LBS.)
3030 1.15/16	78592115	1 15/16	7.58	3535 1.3/8	78593106	1 3/8	14.76	4030 3.5/8	78586310	3 5/8	14
30,302	78592200	2	7.39	3535 1.7/16	78593107	1 7/16	14.58	4030 3.11/16	78586311	3 11/16	13
3030 2.1/8	78592202	2 1/8	7.11	3535 1.1/2	78593108	1 1/2	14.4	4030 3.3/4	78586312	3 3/4	12.7
4030 3.7/8	78586314	3 7/8	12.9	4535 3.1/2	78587308	3 1/2	21.3	5040 3.3/4	78588312	3 3/4	29.7
4030 3.15/16	78586315	3 15/16	12.6	4535 3.9/16	78587309	3 9/16	21.1	5040 3.13/16	78588313	3 13/16	29.4
40,304	78586400	4	12.6	4535 3.5/8	78587310	3 5/8	21	5040 3.7/8	78588314	3 7/8	29
4030 4.1/8	78586402	4 1/8	12.6	4535 3.11/16	78587311	3 11/16	20.3	5040 3.15/16	78588315	3 15/16	28.7
4030 4.3/16	78586403	4 3/16	12.6	4535 3.3/4	78587312	3 3/4	19.9	50,404	78588400	4	27.8
4030 4.1/4	78586404	4 1/4	12.6	4535 3.13/16	78587313	3 13/16	19.6	5040 4.1/8	78588402	4 1/8	27.5
4030 4.3/8	78586406	4 3/8	12.6	4535 3.7/8	78587314	3 7/8	19.3	5040 4.3/16	78588403	4 3/16	27.2
4030 4.7/16	78586407	4 7/16	11.8	4535 3.15/16	78587315	3 15/16	18.9	5040 4.1/4	78588404	4 1/4	27
4040 1.7/16	78594107	1 7/16	24	45,354	78587400	4	18.7	5040 4.3/8	78588406	4 3/8	26
4040 1.1/2	78594108	1 1/2	22	4535 4.1/8	78587402	4 1/8	18.6	5040 4.7/16	78588407	4 7/16	25.1
4040 1.5/8	78594110	1 5/8	22.13	4535 4.3/16	78587403	4 3/16	18.5	5040 4.1/2	78588408	4 1/2	23.6
4040 1.11/16	78594111	1 11/16	21.8	4535 4.1/4	78587404	4 1/4	17.8	5040 4.3/4	78588412	4 3/4	22.9
4040 1.3/4	78594112	1 3/4	21.97	4535 4.3/8	78587406	4 3/8	16.8	5040 4.7/8	78588414	4 7/8	22.2
4040 1.7/8	78594114	1 7/8	21	4535 4.7/16	78587407	4 7/16	15.4	5040 4.15/16	78588415	4 15/16	20.6
4040 1.15/16	78594115	1 15/16	21.18	4535 4.1/2	78587408	4 1/2	15.3	50,405	78588500	5	20.5
40,402	78594200	2	21.11	4535 4.3/4	78587412	4 3/4	15.2	5050 2.7/16	78597207	2 7/16	38.71
4040 2.1/8	78594202	2 1/8	20.59	4535 4.7/8	78587414	4 7/8	15.1	5050 2.11/16	78597211	2 11/16	37.42
4040 2.3/16	78594203	2 3/16	20.32	4535 4.15/16	78587415	4 15/16	14.9	5050 2.15/16	78597215	2 15/16	35.97
4040 2.1/4	78594204	2 1/4	20.19	4545 1.15/16	78595115	1 15/16	29.85	5050 3.3/8	78597306	3 3/8	33.01
4040 2.3/8	78594206	2 3/8	19.64	45,452	78595200	2	29.76	5050 3.7/16	78597307	3 7/16	32.6
4040 2.7/16	78594207	2 7/16	19.3	4545 2.3/16	78595203	2 3/16	29.06	5050 3.5/8	78597310	3 5/8	31.23
4040 2.1/2	78594208	2 1/2	18.8	4545 2.3/8	78595206	2 3/8	28.16	5050 3.7/8	78597314	3 7/8	29.3
4040 2.5/8	78594210	2 5/8	18.65	4545 2.7/16	78595207	2 7/16	27.9	5050 3.15/16	78597315	3 15/16	28.79
4040 2.11/16	78594211	2 11/16	18.33	4545 2.5/8	78595210	2 5/8	27.03	50,504	78597400	4	28.3
4040 2.3/4	78594212	2 3/4	18.21	4545 2.3/4	78595212	2 3/4	26.48	5050 4.1/4	78597404	4 1/4	24.02
4040 2.7/8	78594214	2 7/8	17.41	4545 2.7/8	78595214	2 7/8	25.71	5050 4.3/8	78597406	4 3/8	25.08
4040 2.15/16	78594215	2 15/16	17.08	4545 2.15/16	78595215	2 15/16	25.41	5050 4.7/16	78597407	4	24.4
40,403	78594300	3	16.79	45,453	78595300	3	25.15	5050 4.1/2	78597408	4 1/2	23.89
4040 3.1/8	78594302	3 1/8	16.17	4545 3.1/8	78595302	3 1/8	24.31	12 5050 4.7/8	78597414	4 7/8	22.25
4040 3.3/16	78594303	3 3/16	15.82	4545 3.3/16	78595303	3 3/16	24	12 5050 4.15/16	78597415	4 15/16	21.67
4040 3.1/4	78594304	3 1/4	15.52	4545 3.1/4	78595304	3 1/4	23.83	12 5050 5.	78597500	5	20.94
4040 3.3/8	78594306	3 3/8	14.7	4545 3.3/8	78595306	3 3/8	22.8	60,503	78598300	3	65
4040 3.7/16	78594307	3 7/16	14.42	4545 3.7/16	78595307	3 7/16	22.31	6050 3.1/4	78598304	3 1/4	65
4040 3.1/2	78594308	3 1/2	14.03	4545 3.1/2	78595308	3 1/2	22.1	6050 3.7/16	78598307	3 7/16	65
4040 3.5/8	78594310	3 5/8	13.37	4545 3.5/8	78595310	3 5/8	21.22	60,504	78598400	4	65
4040 3.11/16	78594311	3 11/16	13.87	4545 3.3/4	78595312	3 3/4	20.31	6050 4.7/16	78598407	4 7/16	64.2
4040 3.3/4	78594312	3 3/4	13.45	4545 3.7/8	78595314	3 7/8	19.34	6050 4.15/16	78598415	4 15/16	58.24
4040 3.7/8	78594314	3 7/8	12.9	4545 3.15/16	78595315	3 15/16	18.96	6050 5.7/16	78598507	5 7/16	52.3
4040 3.15/16	78594315	3 15/16	12.46	45,454	78595400	4	18.61	6050 5.15/16	78598515	5 15/16	47.24
40,404	78594400	4	12.05	4545 4.1/8	78595402	4 1/8	17.52	60,506	78598600	6	46.38

4040 4.1/8	78594402	4 1/8	11.22	4545 4.3/16	78595403	4 3/16	17.14	70,603	78599300	3	95
------------	----------	-------	-------	-------------	----------	--------	-------	--------	----------	---	----

NO. PRODUCTO SERIES 7848 Y 7858

DESCRIPCIÓN	CÓDIGO	DIÁM. MÁX. BARRENO (PULG.)	PESO (LBS.)	DESCRIPCIÓN	CÓDIGO	DIÁM. MÁX. BARRENO (PULG.)	PESO (LBS.)	DESCRIPCIÓN	CÓDIGO	DIÁM. MÁX. BARRENO (PULG.)	PESO (LBS.)
4040 4.3/16	78594403	4 3/16	10.7	4545 4.1/4	78595404	4 1/4	14.89	7060 3.1/4	78599304	3 1/4	95
4040 4.3/8	78594406	4 3/8	9.52	12 4545 4.3/8	78595406	4 3/8	16.94	7060 3.7/16	78599307	3 7/16	95
4040 4.7/16	78594407	4 7/16	8.88	12 4545 4.7/16	78595407	4	16.33	7060 4.15/16	78599415	4 15/16	91.95
4535 1.15/16	78587115	1 15/16	31	12 4545 4.1/2	78595408	4 1/2	15.84	7060 5.7/16	78599507	5 7/16	84.48
45,352	78587200	2	29.7	12 4545 4.3/4	78595412	4 3/4	13.92	7060 5.15/16	78599515	5 15/16	78.16
4535 2.1/16	78587201	2 1/16	23.65	12 4545 4.7/8	78595414	4 7/8	12.85	70,606	78599600	6	76.64
4535 2.1/8	78587202	2 1/8	29.3	12 4545 4.15/16	78595415	4 15/16	12.27	7060 6.7/16	78599607	6 7/16	68.08
4535 2.3/16	78587203	2 3/16	29	5040 2.7/16	78588207	2	39.5	7060 6.1/2	78599608	6 1/2	68.64
4535 2.1/4	78587204	2 1/4	23.15	5040 2.1/2	78588208	2 1/2	38.3	7060 6.15/16	78599615	6 15/16	62.13
4535 2.5/16	78587205	2 5/16	28.6	5040 2.9/16	78588209	2	37.7	70,607	78599700	7	60.64
4535 2.3/8	78587206	2 3/8	28.4	5040 2.5/8	78588210	2 5/8	37.1	8065 5.7/16	78599517	5 7/16	97.65
4535 2.7/16	78587207	2 7/16	28	5040 2.11/16	78588211	2 11/16	36.9	8065 5.15/16	78599525	5 15/16	105.7
4535 2.1/2	78587208	2 1/2	26.7	5040 2.3/4	78588212	2 3/4	36.6	8065 6.7/16	78599617	6 7/16	102.3
4535 2.9/16	78587209	2 9/16	26.4	5040 2.13/16	78588213	2 13/16	36.5	8065 6.1/2	78599618	6 1/2	101.78
4535 2.5/8	78587210	2 5/8	25.9	5040 2.7/8	78588214	2 7/8	36.4	8065 6.15/16	78599625	6 15/16	92
4535 2.11/16	78587211	2 11/16	25.4	5040 2.15/16	78588215	2 15/16	36.2	80,657	78599710	7	91.1
4535 2.3/4	78587212	2 3/4	25	50,403	78588300	3	35.6	8065 7.1/2	78599718	7 1/2	89
4535 2.13/16	78587213	2 13/16	24.9	5040 3.1/8	78588302	3 1/8	34.8	80,658	78599810	8	89.9
4535 2.7/8	78587214	2 7/8	24.8	5040 3.3/16	78588303	3	33.9	1,008,510	78599020	10	157.5
4535 2.15/16	78587215	2 15/16	24.1	5040 3.1/4	78588304	3 1/4	33.2	100,857	78599720	7	245
45,353	78587300	3	24.2	5040 3.5/16	78588305	3	33	100,858	78599820	8	219
4535 3.1/16	78587301	3 1/16	24.2	5040 3.3/8	78588306	3 3/8	32.7	100,859	78599920	9	190
4535 3.1/8	78587302	3 1/8	24.1	5040 3.7/16	78588307	3	32	12,010,012	78599120	12	290
4535 3.3/16	78587303	3 3/16	23.8	5040 3.1/2	78588308	3 1/2	31.7				
4535 3.1/4	78587304	3 1/4	23.1	5040 3.9/16	78588309	3	31.4				
4535 3.5/16	78587305	3 5/16	22.7	5040 3.5/8	78588310	3	31.1				
4535 3.3/8	78587306	3 3/8	22.4	5040 3.11/16	78588311	3 11/16	30.4				



DRIVEN BY POSSIBILITY™





DRIVEN BY POSSIBILITY™

GATES DE MÉXICO S.A. DE C.V.

AV. VASCO DE QUIROGA 3200, PISO 1, CENTRO CIUDAD SANTA FE, C.P. 01210, CDMX.
TEL. 55 2000 2700

**CENTRO DE DISTRIBUCIÓN Y SERVICIO VESTA PARK
TOLUCA II**

ISIDRO FABELA NO. 120 EDIFICIO INDUSTRIAL S-6
SAN BLAS OTZACATIPAN, C.P. 50230 TOLUCA, MÉXICO.
TEL. 722 265 5300

**CENTRO DE DISTRIBUCIÓN Y SERVICIO
GUADALAJARA**

CARRETERA A SAN MARTÍN DE LAS FLORES NO. 520
PARQUE INDUSTRIAL PROLOGIS NAVE 2-B, C.P. 45629, TLAQUEPAQUE, JAL.
TEL. 33 3001 8200

CENTRO DE DISTRIBUCIÓN Y SERVICIO MONTERREY

BLVD. JOSÉ LÓPEZ PORTILLO NO.333 INT. BODEGAS 209
COL. VALLE DEL CANADÁ, C.P. 66050, GENERAL ESCOBEDO, N.L.
TEL. 81 8852 8000

LA INFORMACIÓN CONTENIDA EN ESTE CATÁLOGO TÉCNICO ES LA CORRECTA HASTA EL MOMENTO DE SU IMPRESIÓN Y ESTÁ SUJETA A CAMBIOS SIN PREVIO AVISO; POR LO CUAL NO ASUMIMOS RESPONSABILIDAD ALGUNA POR SUS ERRORES U OMISIONES, PARA ACTUALIZACIONES, QUEDA EXPRESAMENTE PROHIBIDA LA REPRODUCCIÓN TOTAL O PARCIAL DE ESTE MATERIAL, SIN EL PERMISO EXPRESO Y POR ESCRITO DE GATES DE MÉXICO S.A. DE C.V.

LA DISTRIBUCIÓN DE ESTE CATÁLOGO TÉCNICO ES GRATUITA.

**PARA MAYOR INFORMACIÓN FAVOR DE CONTACTAR
A TU REPRESENTANTE DE VENTAS GATES®.**